

**Development of a Dynamic Biomechanical Model for Load Carriage:  
Phase II Part A:**

**Initial Development of a Novel Strap Tension Sensor**

by:

S.A. Reid, G. A. B. Sanders, J. A. Good,  
J.T. Bryant, and J.M. Stevenson

Ergonomics Research Group  
Queen's University  
Kingston, Ontario, Canada  
K7L 3N6

Project Manager:  
J. M. Stevenson  
(613) 533-6288

PWGSC Contract No. W7711-0-7632-02  
on behalf of  
DEPARTMENT OF NATIONAL DEFENCE

as represented by  
Defence Research and Development Canada -Toronto  
1133 Sheppard Avenue West  
North York, Ontario, Canada  
M3M 3B9

DRDC Scientific Authority:  
Maj Linda Bossi  
(416) 635-2197

August 2005

The scientific or technical validity of this Contract Report is entirely the responsibility of the contractor and the contents do not necessarily have the approval or endorsement of Defence R&D Canada

© Her Majesty the Queen as represented by the Minister of National Defence, 2005

© Sa Majesté la Reine, représentée par le ministre de la Défense nationale, 2005



## **Abstract**

This work was undertaken in support of the DLR research thrust “Development of a Dynamic Biomechanical Load Carriage Model”. This document details the design and development of a novel transducer (StrapSensor™) that can be attached to a flexible membrane or strap to measure material tension. The transducer achieves an exceptionally small footprint (<13 mm) and can be inserted into any strap on conventional Load Carriage (LC) systems to record strap tensions. No modification to the surface is required for attachment and it is readily repositioned. A variety of load ranges can be accommodated using the same transducer theory. The device demonstrated a highly linear response ( $R^2 = 0.98 - 0.99$ ) and low repeatable hysteresis (<6.5% error over multiple load-unload cycles).

This is a potentially exploitable technical development and formal disclosure has been made to protect any intellectual property arising from this work. Initial patent searches have discovered an expired patent on a related similar device and further exploration is being made to determine if this new device is a “substantive “ improvement and subsequently remain patentable. Opportunities (other than by patenting) may exist for commercialization by protecting aspects of this device as a Registered Industrial Design.

## Résumé

Les travaux en cause ont été entrepris à l'appui du vecteur de recherche de DLR intitulé « Élaboration d'un modèle biomécanique dynamique du transport de charge ». Le document décrit en détail la conception et le développement d'un nouveau transducteur (StrapSensor<sup>MC</sup>) qui peut être fixé à une membrane souple ou à une sangle pour mesurer la traction subie par le matériau. L'encombrement du transducteur est exceptionnellement faible (<13 mm), et celui-ci peut être intégré à n'importe quel type de système classique de transport de charge (LC) pour enregistrer les tractions des sangles. Le transducteur ne nécessite aucune modification de sa surface pour la fixation et il est facile à repositionner. Le même type de transducteur permet de prendre en compte différentes plages de charges. Le dispositif a présenté une réponse linéaire élevée ( $R^2 = 0,98 - 0,99$ ) et une faible hystérésis répétable (erreur <6,5 % pour de multiples cycles de chargement-déchargement).

Ce dispositif constitue une innovation technique exploitable, et une divulgation officielle en a été faite afin de protéger tous droits de propriété intellectuelle qui pourraient découler des recherches. Un examen initial des brevets a permis de découvrir un brevet expiré pour un dispositif similaire. Des vérifications supplémentaires sont menées pour déterminer si ce nouveau dispositif constitue une amélioration « substantielle » et pourrait de ce fait être breveté. D'autres avenues (que le brevetage) sont possibles pour la commercialisation du dispositif en protégeant certains de ses aspects au moyen d'un dessin industriel enregistré.

## Executive Summary

The current design for strap force sensors is dog-bone shaped and made out of an aluminium base plate with rosette strain gauges that require a minimum of 6 cm of strap length. These strap force sensors were linear and robust and the design worked well for shoulder straps and the waist belt. However, they are not suitable for load-lifter straps and hip stabilizer straps because of length of strap available and the radius of curvature at some locations around the shoulders and hips. During Phase 1 Part A of the Dynamic Biomechanical Modelling for load carriage contracts, smaller strap tension sensors were created to withstand the same tension ranges (~ 50N to 100N) as larger dog-bone sensors. Over the course of that development, a new invention emerged.

The purpose of this report is to describe and develop a novel transducer (StrapSensor™) that can be attached to a flexible membrane or strap to measure material tension. The transducer achieves an exceptionally small footprint (<13 mm) and can be inserted into any strap on conventional Load Carriage (LC) systems to record strap tensions. No modification to the surface is required for attachment and it is readily repositioned. A variety of load ranges can be accommodated using the same transducer theory. The device demonstrated a highly linear response ( $R^2 = 0.98 - 0.99$ ) and low repeatable hysteresis (<6.5% error over multiple load-unload cycles).

This novel transducer (StrapSensor™) is a potentially exploitable technical development and formal disclosure has been made to protect any intellectual property arising from this work. Initial patent searches have discovered an expired patent on a related similar device and further exploration is being made to determine if this new device is a “substantive “ improvement and subsequently remain patentable. Opportunities (other than by patenting) may exist for commercializing this by protecting aspects of this device as a Registered Industrial Design.

## Sommaire

Actuellement, les capteurs de force de sangle sont en forme d'os à chien et consistent en une plaque d'aluminium dotée d'extensomètres en rosette qui nécessitent une sangle d'au moins 6 cm de longueur. Ces capteurs de force de sangle sont linéaires et robustes, et leur conception est bien adaptée aux sangles portées aux épaules et à la taille. Toutefois, ils ne conviennent pas aux sangles de levage de charge et aux sangles de stabilisation aux hanches en raison de la longueur des sangles disponible et du rayon de courbure à certaines parties des épaules et des hanches. Dans le cadre de la partie A de la phase 1 du contrat concernant le modèle biomécanique dynamique de transport de charge, des capteurs de traction de sangle plus petits ont été fabriqués; ils peuvent tenir aux mêmes plages de traction (~ 50 N à 100 N) que les plus gros capteurs en forme d'os à chien. Durant cette période, une nouvelle invention a vu le jour.

Le présent rapport vise à décrire et à développer un nouveau transducteur (StrapSensor<sup>MC</sup>) qui peut être fixé à une membrane souple ou à une sangle pour mesurer la traction subie par le matériau. L'encombrement du transducteur est exceptionnellement faible (<13 mm), et celui-ci peut être intégré à n'importe quel type de système classique de transport de charge (LC) pour enregistrer les tensions des sangles. Le transducteur ne nécessite aucune modification de sa surface pour la fixation et il est facile à repositionner. Le même type de transducteur permet de prendre en compte différentes plages de charges. Le dispositif a présenté une réponse linéaire élevée ( $R^2 = 0,98 - 0,99$ ) et une faible hystérésis répétable (erreur <6,5 % pour de multiples cycles de chargement-déchargement).

Ce nouveau transducteur (StrapSensor<sup>MC</sup>) constitue une innovation technique exploitable, et une divulgation officielle en a été faite afin de protéger tous droits de propriété intellectuelle qui pourraient découler des recherches. Un examen initial des brevets a permis de découvrir un brevet expiré pour un dispositif similaire. Des vérifications supplémentaires sont menées pour déterminer si ce nouveau dispositif constitue une amélioration « substantielle » et pourrait de ce fait être breveté. D'autres avenues (que le brevetage) sont possibles pour la commercialisation du dispositif en protégeant certains de ses aspects au moyen d'un dessin industriel enregistré.

## Table of Contents

<b>Abstract</b> .....	<b>i</b>
<b>Résumé</b> .....	<b>ii</b>
<b>Executive Summary</b> .....	<b>iii</b>
<b>Sommaire</b> .....	<b>iv</b>
<b>Table of Contents</b> .....	<b>v</b>
<b>Index of Figures</b> .....	<b>vi</b>
<b>Index of Tables</b> .....	<b>vi</b>
<b>1.0 Introduction</b> .....	<b>1</b>
<b>2.0 Background</b> .....	<b>1</b>
<b>3.0 Sensor Theory</b> .....	<b>3</b>
<b>4.0 Description of Device</b> .....	<b>4</b>
<b>5.0 Testing Algorithm</b> .....	<b>4</b>
5.1 Estimation of Failure Load.....	5
5.2 Determination of Linearity.....	5
5.3 Determination Repeatability and Hysteresis.....	5
5.4 Pursuit of Intellectual Property Protection.....	5
<b>6.0 Results</b> .....	<b>6</b>
6.1 Estimation of Failure Load.....	6
6.2 Determination of Linearity.....	6
6.3 Determination Repeatability and Hysteresis.....	7
<b>7.0 Conclusions</b> .....	<b>8</b>
<b>8.0 Next Steps</b> .....	<b>8</b>
<b>9.0 References</b> .....	<b>9</b>
<b>Appendix A: StrapSensor™ Design Spreadsheet</b> .....	<b>A-1</b>
<b>Appendix B: Estimate of Failure</b> .....	<b>B-1</b>
<b>Appendix C: Static and Continuous Loading Tests</b> .....	<b>C-1</b>
<b>Appendix D: Discontinuity Tests</b> .....	<b>D-1</b>
<b>Appendix E: Repeatability Tests</b> .....	<b>E-1</b>
<b>Appendix F: Invention Disclosure Form</b> .....	<b>F-1</b>
<b>Appendix G: Plots</b> .....	<b>G-1</b>

## Index of Figures

FIGURE 1:	ENTRAN EL20 TENSION LOAD CELL .....	1
FIGURE 2:	THE 'DOG BONE' SENSOR.....	2
FIGURE 3:	CLASSIC BENT BEAM.....	3
FIGURE 4:	SCHEMATIC OF STRAPSENSOR (TM).....	4
FIGURE 5:	TEST OF ALUMINUM SAMPLE B, FORCE VS STRAIN CURVE .....	7
FIGURE 6:	TYPICAL CYCLIC LOADING HYSTERESIS.....	7
FIGURE 7:	AVERAGE RESPONSE, DATA FOR 10 LOAD AND 10 UNLOAD CYCLES. ....	8
FIGURE B1:	DIAGRAM OF DIMENSIONS RECORDED.....	B-1
FIGURE C1:	STATIC TEST SET UP.....	C-1
FIGURE E1:	TYPICAL STRESS STRAIN RESPONSE OVER TEN LOAD - UNLOAD CYCLES.....	E-2
FIGURE G1:	SAMPLE A, AL 6061-T (1", 350 $\Omega$ , FULL BRIDGE, T=1.016 MM) .....	G-1
FIGURE G2:	SAMPLE B, AL 6061-T6, (1", 350 $\Omega$ , FULL BRIDGE, T=2.032MM) .....	G-1
FIGURE G3:	SAMPLE C, AL 6061-T6, (1000 $\Omega$ , HALF BRIDGE, T=1.676 MM).....	G-2
FIGURE G4:	SAMPLE E, AL 6061-T6, (1", 350 $\Omega$ , HALF BRIDGE, T=1.727).....	G-2
FIGURE G5:	P2, 316SS CYCLIC LOADING HYSTERESIS (FOR 1" STRAP) .....	G-3
FIGURE G6:	P3, 316SS, CYCLIC LOADING HYSTERESIS (FOR 1" STRAP) .....	G-3
FIGURE G7:	P4, 316SS CYCLIC LOADING HYSTERESIS (FOR 1" STRAP) .....	G-4
FIGURE G8:	P5, 316SS, CYCLIC LOADING HYSTERESIS (FOR 1" STRAP) .....	G-4
FIGURE G9:	P6, 316SS CYCLIC LOADING HYSTERESIS (FOR 1" STRAP).....	G-5
FIGURE G10:	P7, 316SS CYCLIC LOADING HYSTERESIS (FOR 2" STRAP) .....	G-5
FIGURE G11:	P8, 316SS CYCLIC LOADING HYSTERESIS (FOR 2" STRAP).....	G-6
FIGURE G12:	P9, 316SS CYCLIC LOADING HYSTERESIS (FOR 1" STRAP) .....	G-6
FIGURE G13:	P10, 316SS CYCLIC LOADING HYSTERESIS (FOR 1" STRAP) .....	G-7

## Index of Tables

TABLE 1:	SAMPLE B (ALUMINUM) CONFIGURATION .....	6
TABLE B1:	ALUMINIUM FAILURE TEST RESULTS.....	B-1
TABLE B2:	316SS FAILURE TEST RESULTS .....	B-2
TABLE B3:	ESTIMATED AND EXPECTED FAILURE .....	B-2
TABLE C1:	TABLE OF SENSOR CONFIGURATION .....	C-2
TABLE D1:	SAMPLE DIMENSIONS.....	D-1
TABLE D2:	DISCONTINUITY POINTS .....	D-2
TABLE E1:	CALIBRATION OF 316 STAINLESS STEEL SENSORS .....	E-2



## 1.0 Introduction

DRDC Toronto has received approval to develop a biomechanical model to be used to predict the distribution and magnitude of the loads experienced by a soldier during load carriage. Several projects have been initiated under PWGSC Contract W7711-0-7632 to support the development of a biomechanical model. The ability to accurately measure instantaneous strap tension is critical in analysing the load distribution in an indeterminate system. Multiple solutions to the dynamic equations exist and accurate experimental values are necessary to ensure that model responses correspond to the physical system response.

## 2.0 Background

At present there are few sensors that can be configured to measure forces in loaded straps. A technology search, including patents, was performed via the Internet. Only one type of belt tension sensor was found in addition to the in-line axial load cells previously developed by the Queen's University ERG (PWGSC Contracts W7711-4-7225/01-XSE and W7711-0-7632-01). A typical commercial belt transducer, the Entran EL20 Tension Load Cell, is illustrated in Figure 1. It is used for measuring the forces in a seat belt during automotive testing. The belt webbing is threaded under the bars and pushes on an instrumented frame. The load cell in the frame gives an output that is calibrated and converted to a force. This sensor is 73 mm x 35 mm x 16.5 mm. When in place both sides of the strap are covered by the sensor, which may cause a pressure point if it came in contact with a user.

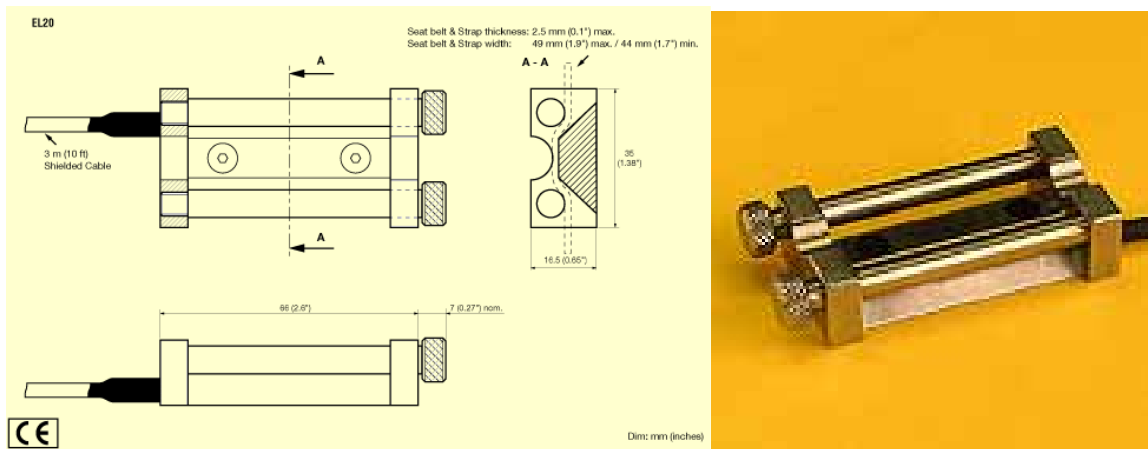

Figure 1: Entran EL20 Tension Load Cell

The 'Dog Bone' (Figure 2) in-line axial load sensor is an instrumented flat plate that is attached to the strap by a mechanical means such as removable clips or sewing. This sensor, (dimensions 37 x 28 x 1mm), requires approximately 80 – 100 mm of clear strapping for mounting. Sufficient slack must be maintained in the strap to completely

unload it, allowing the transducer to carry the complete load. Since the sensor is sensitive to bending, extreme care must be taken during placement and handling to ensure no bending of the strain gauges occurs.<sup>1</sup>

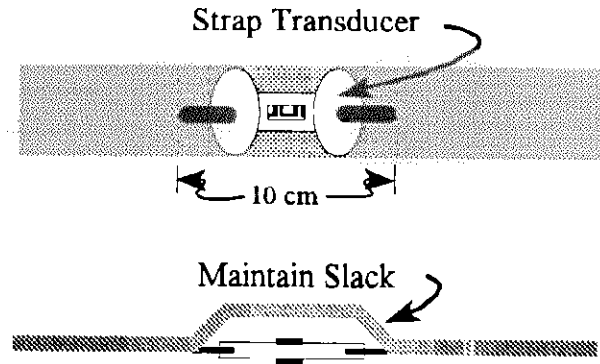

Figure 2: The 'Dog Bone' Sensor

There are straps in some load carriage equipment that when tensioned do not have sufficient free length to accommodate the 'dog bone' or have less than 100 mm of slack length available. Under PWGSC Contract # W7711-0-7632-01, an optimized version of the in-line strap transducer was designed and built. These sensors achieved a 29 x 6 mm footprint and are hand sewn in-place to further reduce the needed free strap length to 60 – 70 mm. The compact nature of these sensor designs makes them a good choice for use in the field and in the laboratory. This sensor however, requires a moderate amount of set up time to be attached to the strap and cannot be easily repositioned. It also makes it more difficult to test LC systems belonging to individuals who require their LC system on an ongoing basis.

There is a need for an extremely compact strap force sensor that can be quickly attached to a strap with minimal free length (<35 mm) without permanently altering the strap.

A strap tension sensor that can be easily placed on any strap is being developed. If successful, this sensor will make it possible to measure forces on a strap without permanently altering the strap in any way. The sensor consists of a seamless tube with a slit cut in it lengthwise and a cylindrical insert. The strap is folded over and the folded end is inserted into the tube through the slit. The insert is then placed in the loop made by the folded strap such that, when the strap is in tension the strap remains in the tube.

This sensor configuration has possible applications beyond LC System testing. The sensor could be used on any strap to provide load-bearing status. For example it would be possible to monitor critical restraining straps for the transport industry to detect either dangerously high or dangerously low (broke/loose) conditions. The sensor could be used to measure the forces in seatbelts during automobile crash tests. They could also be integrated into 'smart cars' that measure the occupants weight to determine how

aggressively to fire the airbag. If a tension sensor was also integrated into the seatbelt the car could adjust how aggressively to restrain the occupant as well. There may be applications in recording the load history of strapping to determine the number of load cycles (fatigue failure monitoring) or instances of overloading. They could also be attached into membranes (sheets) of materials to monitor strain in the material.

The cylindrical tube and insert idea could also be used alone as a method of attaching labelling to straps or flexible membranes.

### 3.0 Sensor Theory

The equations for the model are based on a classic circular beam in pure bending as shown in Figure 3.

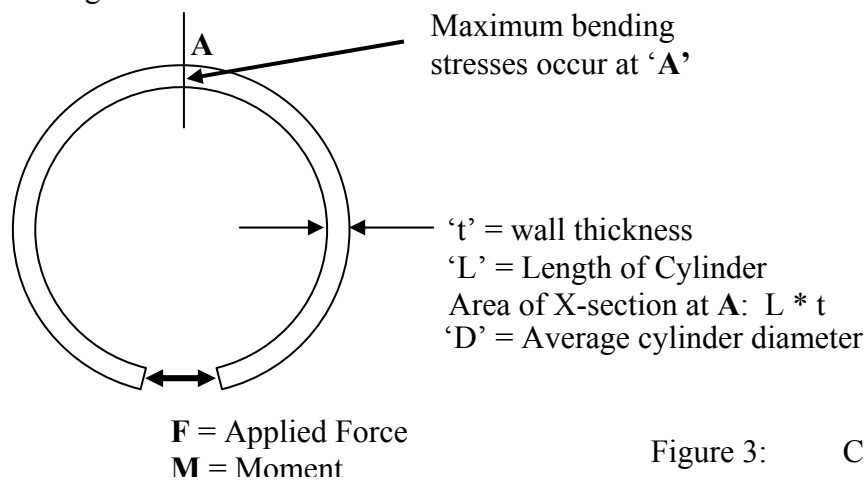

Figure 3: Classic Bent Beam

Stress at A due to tension:

$$\text{Equation 1: } \sigma_t = \frac{F}{A} = \frac{F}{Lt}$$

Stress at A due bending:

Equation 2:

$$\sigma_b = \frac{My}{I} = \frac{FD \times \left(\frac{t}{2}\right)}{\left(\frac{Lt^3}{12}\right)} = \frac{6FD}{Lt^2}$$

Combining Equations 1 and 2 gives:

$$\text{Equation 3: } \sigma = \frac{F}{Lt} + \left[1 + \frac{6D}{t}\right]$$

Solving for the real root of t gives:

$$t = \frac{\frac{F}{L} + \sqrt{\left(\frac{F}{L}\right)^2 + 4\sigma_{allowable}(6FD)}}{2\sigma_{allowable}}$$

This relationship was used to select a range of appropriate geometries and materials, given the expected load range and width of the strap being instrumented. A Microsoft

Excel spreadsheet was written to provide sizing of the transducers blanks based on the dimensions and material properties of available standard seamless tubing sizes. A sample worksheet appears as Appendix A.

## 4.0 Description of Device

The device is an easily insertable transducer for determining the tension in any flexible strap, a woven membrane or a cable (Figure 3). The transducer rides on only one side of the webbing, leaving one side clear of obstruction. This allows the strap or membrane to lie flat against the underlying surface. It employs a novel attachment method that does not require any modification or damage to the material being instrumented. The carrier material for the strain gauges is made from a section of tubing. A slot is cut along the length of the carrier material. The material to be instrumented is folded back onto itself. This fold is inserted into the slot on the carrier. A centre-locking pin is then inserted into the loop formed by the folded material. This pin locks the material inside the carrier tube, preventing the loop from pulling out of the slot. As tension in the material increases, the edges of the slot are pulled open. This creates pure bending in the tube. The maximum bending stress occurs on the centreline of the tube, 180° away from the slot. Strain gauges applied in this location can measure the bending stress. Bending stress will increase linearly (as shown in Equation 3) as the tension in the flexible strap increases.

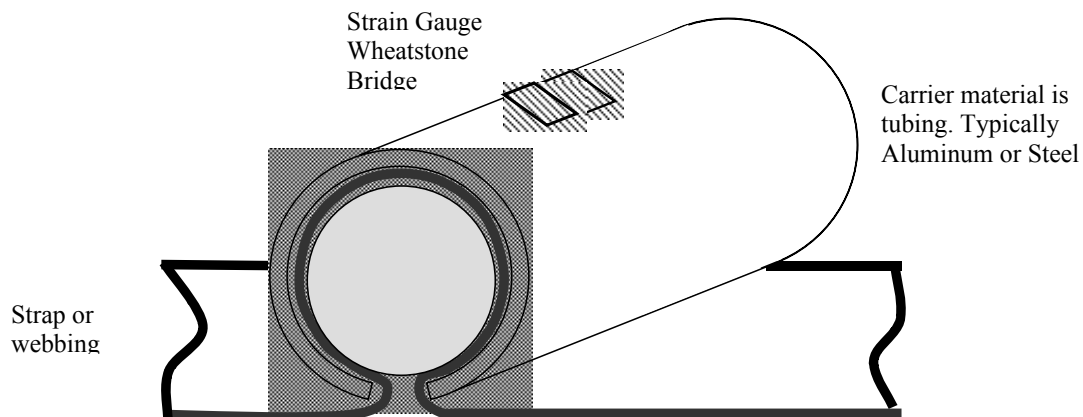

Figure 4: Schematic of StrapSensor (TM)

## 5.0 Testing Algorithm

A testing and development protocol was devised that met the following objectives:

## 5.1 Estimation of Failure Load

This test determined typical failure loads of sensor blanks and compared the results to the calculated values. A complete description of the test protocol and results appears in Appendix B.

## 5.2 Determination of Linearity

A number of StrapSensor™ configurations were constructed and tested for linearity. Each sensor was tested under static and continuous loading. The linearity of the stress-strain response was determined. A complete description of the test protocol and results appears in Appendix C.

## 5.3 Determination Repeatability and Hysteresis

Based on the results from the previous tests, a number of StrapSensor™ were made of the most suitable configuration. Each sensor was loaded and unloaded multiple times, firstly with the StrapSensor™ removed and reinserted between each cycle, then secondly with the sensor remaining in position through multiple cycles.

The force-strain curves were plotted and compared. A force-strain scale factor was determined for each sensor based on the multiple loading unloading cycles. The amount of hysteresis was examined by comparing a predicted value derived from the force-strain scale factor to the actual results. A complete description of the test protocol and results appears in Appendix D.

## 5.4 Pursuit of Intellectual Property Protection

PARTEQ is a Queens University affiliated not-for-profit corporation that is responsible for technology transfer at Queens University.

### *PARTEQ's Mission Statement<sup>1</sup>*

*PARTEQ's mission is to stimulate and facilitate the commercialization of intellectual property generated at Queen's and to enhance and foster linkages between the university research community and industry. Our mission is driven by social responsibility and potential economic return. Queen's is a research-intensive university and PARTEQ provides a means to ensure that discoveries with potential social benefit are properly developed. It is anticipated that commercialization of intellectual property through PARTEQ will generate a future income flow for Queen's which will partially offset declining revenue from other sources.*

Potential Intellectual Property (IP) generated under this contract is covered under the intellectual property agreement between Queens University and D.C.I.E.M. Formal disclosure has been made by means of a Canadian University Invention disclosure form submitted to PARTEQ, see Appendix F. AN initial patent search by the PARTEQ

---

<sup>1</sup> Parteq website: <http://www.parteq.queensu.ca/>

patent lawyer resulted in the identification of a possibly similar device in an expired patent. Further work is being undertaken to determine if the new device provides a “sufficient improvement” or is substantively different from the existing patent. Either of these conditions must exist to justify pursuit of a patent.

**PARTEQ contact name:**

Anne Vivian-Scott, MBA, P.Eng.  
 Manager, Commercial Development  
 PARTEQ Innovations av4@post.queensu.ca  
 Biosciences Complex bus:(613) 533-6000 X75513  
 Queen's University fax:(613) 533-6853  
 Kingston, ON K7L 3N6

## 6.0 Results

### 6.1 Estimation of Failure Load

The results obtained from this test ranged from 40% to 140% of calculated yield. The aluminium samples tended to fail below the calculated yield strength and the stainless steel samples consistently failed above the calculated yield strength. The analytical model proved highly useful in selection of the tubing and in determining a safe load range for testing.

### 6.2 Determination of Linearity

Of the various initial aluminum prototype transducers, Sample B was the most linear, its dimensions are summarized in Table 1. Results from the static and the continuous loading are shown in Figure 6 along with their respective linear correlation coefficients. Of the various initial designs tested, configurations with thicker walls and 350Ω strain gauges in a full Wheatstone bridge performed most reliably. Subsequent sensors were made based on this design but on a 316 stainless steel seamless tubing to increase the load range.

<b>L (in)</b>	1.001
<b>Length (mm)</b>	25.46
<b>Thickness (in)</b>	0.080
<b>Thickness (mm)</b>	2.032
<b>Gauge Type (Ω)</b>	350
<b>Gauge Configuration</b>	Full Bridge
<b>M-M Product #</b>	EA-13-050TG-350
<b>Centre Cylinder Dia. (mm)</b>	1.27

Table 1: Sample B (Aluminum) Configuration

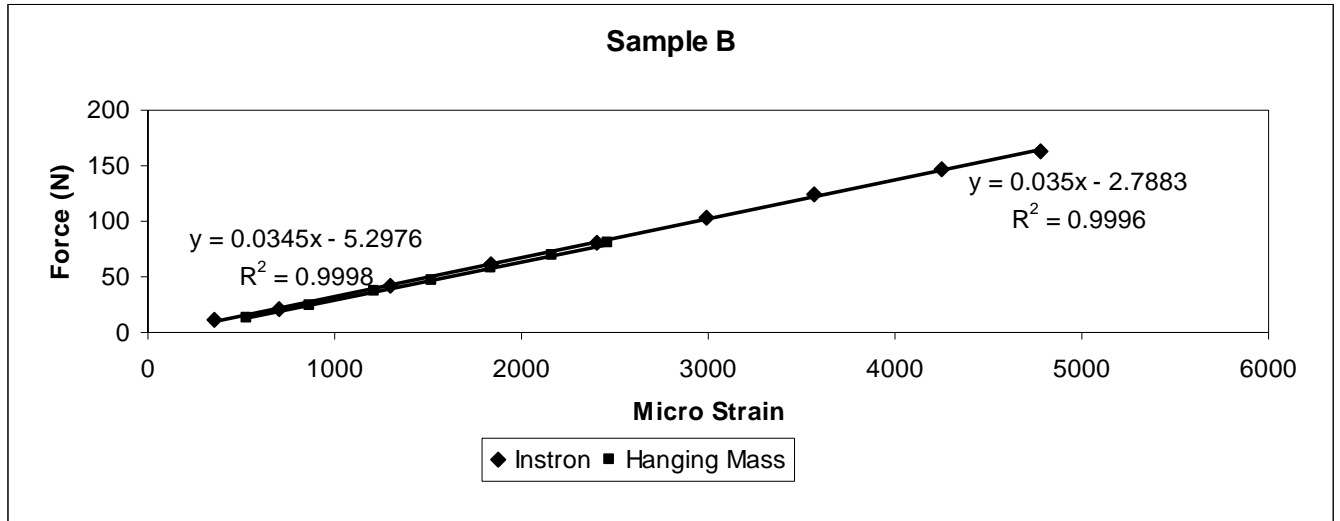

Figure 5: Test of Aluminum Sample B, Force vs Strain Curve

### 6.3 Determination Repeatability and Hysteresis

All stainless steel sensors showed very linear results with limited hysteresis. The average error in 9 samples was 6.33%. Figures 7&8 show typical cyclic loading curves. Trial 1 is the first loading cycle, transducer zeroed when uninstalled. Trial 2 was zeroed after installation in a strap and a single load/unload cycle. Figure 6 shows the Trial 1 and Trial 2 average response curves for 4 complete load-unload cycles.

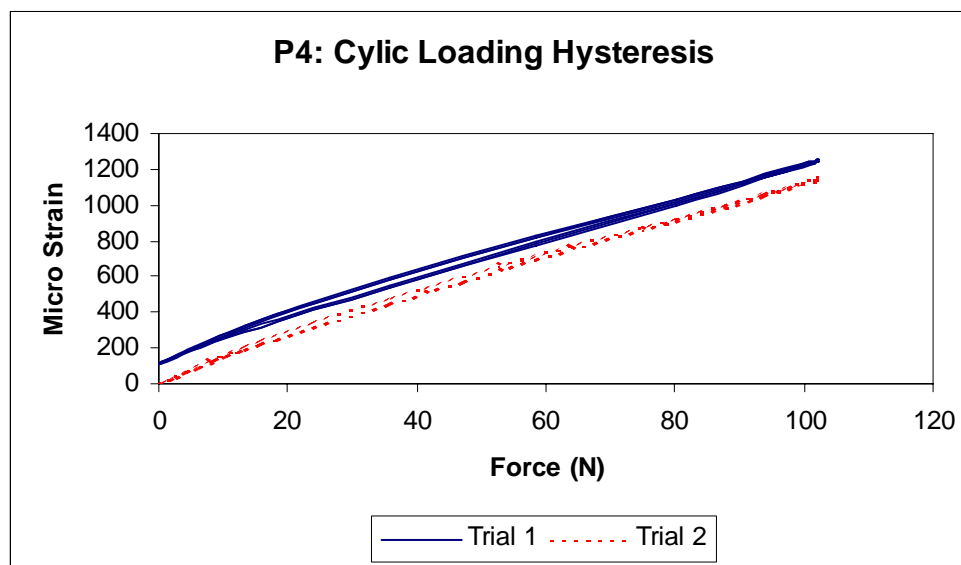

Figure 6: Typical Cyclic Loading Hysteresis

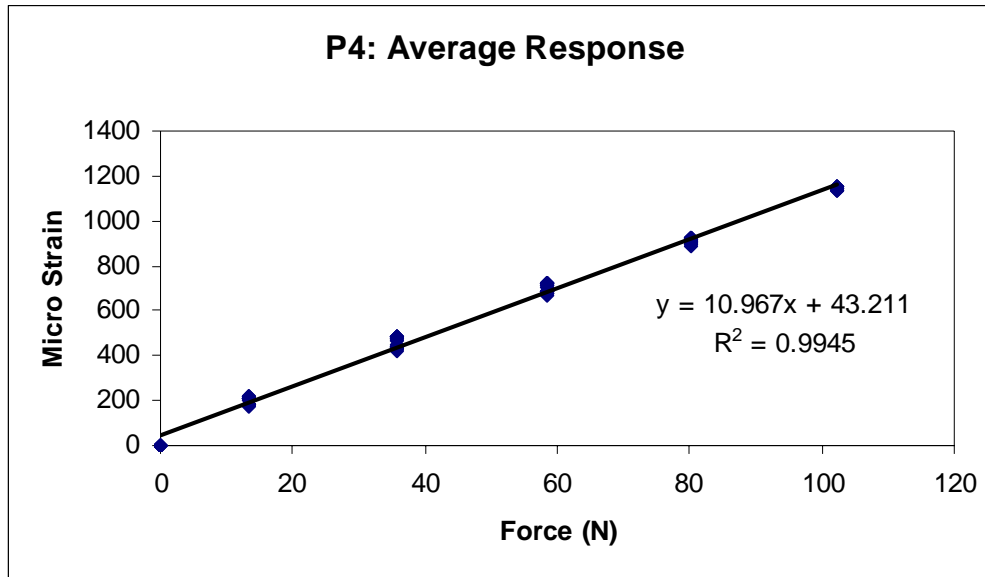

Figure 7: Average Response, data for 10 load and 10 unload cycles.

## 7.0 Conclusions

The concept of the cylindrical StrapSensor™ has been successfully demonstrated. A single wall thickness was tested due to time and material availability constraints. For the load ranges expected in Load Carriage testing stainless steel is the preferred material to avoid over stressing this particular sensor. The expected working load should be less than one quarter the yield strength of the sensor to allow for short duration high force impact loads such as those that may be experience during jumping. The sensors are surprisingly sensitive so the best material and dimensions for the application should be considered without regard for the sensitivity of the sensor. Preliminary results indicated that the insert diameter was not a key factor in sensor response. Inserts that fit snugly, but not tightly, into the sensor worked best from a user interface standpoint. Considerable opportunity exists for a reduction in the average %errors. No attempt was made to achieve the surface quality of materials or environmental control typical of commercial transducer manufacturing facilities.

## 8.0 Next Steps

Final determination of the viability of patenting this concept has not been made. If it is patentable, the next step is to pursue future product development and licensing opportunities. If it is not feasible to patent, the next step would be to determine if there are opportunities to protect aspects of this work as a Registered Industrial Design. In either case, we have developed an in-line sensor with an extremely small footprint (equivalent to the diameter of the transducer carrier cylinder) that can be readily constructed out of standard materials to suit an extremely wide range of operational loads. This sensor can also fit into every strap on a conventional LC system.



## **9.0 References**

1. Reid, S. A. Protocol for the Carriage Simulator Testing. Step 3.1

# Appendix A: StrapSensor™ Design Spreadsheet

Calculation of potential configurations for Springsensor.

This spread sheet calculates the approximate stress / strain state of the available geometries of seamless tubing.

The stress generated by the expected strap load is then compared to the the materials yield strength.

Columns E&F determine if this stress state is between the range of 15 to 35% yield, if yes, then the configuration is flagged as "OK"

**Note:** initial prototypes were selected based on a higher range of allowable stress, 35 to 50% yield.

The transducers were shown to be very sensitive, this selection range was modified to increase the load range.

Prototype Material Identification: SANDVIK (NDE) 08-99 CF SMLS HN7094H SC LOT106854 TP316/316L 1/2" x .065" ASTM A213/A269 ASME SA2

Active Input Fields =

Material: Stainless 316      Enter      Enter expected  
 Yield Strength = 42,061 psi      Length of springsensor      Strap Force (N)      Force (lbs)  
 Mod of Elasticity= 28,427,000 psi       inches            22.43

Available Tube sizes			Material within allowable stress range?		Calculated Stress (psi)	% Yield	Calculated strain (in/in)
OD	t = wall thickness	Smax<35%	Smax>10%				
0.25	0.035	0	1		24256.80	0.58	0.000853
0.25	0.058	1	1	OK	8066.46	0.19	0.000284
0.375	0.035	0	1		37987.06	0.90	0.001336
0.375	0.065	1	1	OK	10217.81	0.24	0.000359
0.4375	0.035	0	1		44852.19	1.07	0.001578
0.4375	0.065	1	1	OK	12208.29	0.29	0.000429
0.5	0.028	0	1		81809.48	1.95	0.002878
0.5	0.035	0	1		51717.32	1.23	0.001819
0.5	0.049	0	1		25732.57	0.61	0.000905
0.5	0.058	0	1		18066.21	0.43	0.000636
0.5	0.065	1	1	OK	14198.77	0.34	0.000499
0.5	0.083	1	1	OK	8415.08	0.20	0.000296
0.5	0.125	1	0		3408.77	0.08	0.000120
0.625	0.049	0	1		32737.80	0.78	0.001152
0.625	0.065	0	1		18179.73	0.43	0.000640
0.75	0.035	0	1		79177.85	1.88	0.002785
0.75	0.058	0	1		28065.95	0.67	0.000987
0.75	0.065	0	1		22160.70	0.53	0.000780
0.75	0.083	1	1	OK	13298.10	0.32	0.000468
0.75	0.125	1	1	OK	5561.67	0.13	0.000196
0.875	0.058	0	1		33065.82	0.79	0.001163
0.875	0.065	0	1		26141.66	0.62	0.000920
1	0.035	0	1		106638.37	2.54	0.003751
1	0.049	0	1		53753.51	1.28	0.001891
1	0.058	0	1		38065.70	0.91	0.001339

## Appendix B: Estimate of Failure

### Objective

The objective of this test was to determine the typical, maximum and minimum failure loads of the metal blanks. This was used for two purposes; first to establish an appropriate maximum applied load for subsequent transducer testing, and secondly to compare observed failure loads to the calculated values.

### Procedure

1. Sensors blanks were made up without strain gauges for failure testing.
2. The diameter of the insert cylinder (d), the wall thickness of the outer cylinder (t), the length of the outer cylinder (L) and material were recorded for each sample.
3. Each sample was placed on a strap and either end of the strap was securely held in the jaws of an Instron<sup>®</sup> universal test machine.
4. A uniaxial tensile test was performed at a rate of 10 mm/min until the force momentarily decreased with increased sample extension.
5. This load was recorded as the estimated failure load.

### Results

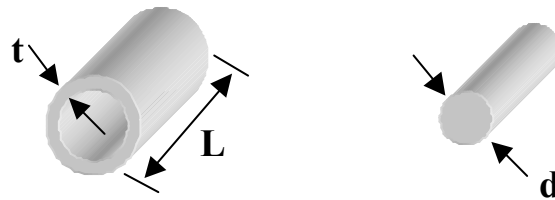

Figure B1: Diagram of Dimensions Recorded

Sample 1 Aluminium 6061-T6	L	1.003 in	25.476 Mm
	t	0.077 in	1.956 Mm
	d	0.08 in	2.032 Mm
	$F_{\text{failure}}$	28.7 Kg	281.547 N
Sample 2 Aluminium 6061-T6	L	0.999 in	25.375 Mm
	t	0.068 in	1.727 mm
	d	0.0582 in	1.478 mm
	$F_{\text{failure}}$	11.5 kg	112.815 N
Sample 3 Aluminium 6061-T6	L	0.997 in	25.324 mm
	t	0.039 in	0.991 mm
	d	0.05 in	1.27 mm
	$F_{\text{failure}}$	9.0 kg	88.29 N
Sample 4 Aluminium 6061-T6	L	0.995 in	25.273 mm
	t	0.076 in	1.930 mm
	d	0.05 in	1.27 mm
	$F_{\text{failure}}$	21.0 kg	206.01 N

Table B1: Aluminium Failure Test Results

Sample S1 316SS	L	1.004 in	25.5016 mm
	t	0.065 in	1.651 mm
	d	0.249 in	6.3246 mm
	F <sub>failure</sub>	39.8 kg	390 N
Sample S2 316SS	L	1.003 in	25.4762 mm
	t	0.065 in	1.651 mm
	d	0.249 in	6.3246 mm
	F <sub>failure</sub>	27.3 kg	267.813 N
Sample S3 316SS	L	1.002 in	25.4508 mm
	t	0.064 in	1.6256 mm
	d	0.249 in	6.3246 mm
	F <sub>failure</sub>	42.8 kg	420 N
Sample S5 316SS	L	1.985 in	50.419 mm
	t	0.065 in	1.651 mm
	d	0.250 in	6.35 mm
	F <sub>failure</sub>	85.2 kg	835.812 N
Sample S6 316SS	L	1.990 in	50.546 mm
	t	0.065 in	1.651 mm
	d	0.250 in	6.35 mm
	F <sub>failure</sub>	89.5 kg	878 N

Table B2: 316SS Failure Test Results

	Expected Yield	Yield	% of expected Yield
Sample 1 (AL)	280.8	281.5	100.3
Sample 2 (AL)	280.8	112.8	40.2
Sample 3 (AL)	155.0	88.3	57.0
Sample 4 (AL)	280.0	206.0	73.6
Sample S1 (SS)	296.0	390.4	131.9
Sample S2 (SS)	296.0	267.8	90.5
Sample S3 (SS)	296.0	419.9	141.8
Sample S5 (SS)	592.5	835.8	141.1
Sample S6 (SS)	592.5	878.0	148.2

Table B3: Estimated and Expected Failure

## Conclusion

The results obtained from this test ranged from 40% to 100% of calculated yield for the 6061-T6 aluminum. Calculated yield was typically conservative in predicting the failure loads of 316 stainless, ranging from 90% to 148% of the expected value.

## Appendix C: Static and Continuous Loading Tests

### Objective (of both tests)

The objective of these tests was to evaluate various sensor – gauge combinations to determine which combination was best suited for the application.

### Static Hanging Mass Procedure

1. The apparatus was weighed. The StrapSensor™ to be tested was inserted into the strap and attached to the strain indicator.
2. The strain indicator was set to the appropriate strain gauge factor and bridge configuration.
3. The strain gauge indicator was then zeroed with the StrapSensor™ unloaded.
4. The bucket assembly was then attached. The complete test set up is shown (Figure 9).
5. The strain reading was recorded.
6. Mass was gradually added to the bucket and the strain reading was recorded with each mass addition.
7. The test was stopped at approximately 75% of the yield strength of the sensor.



Figure C1: Static Test Set Up

### Continuous Instron® Loading Procedure

1. The diameter of the insert cylinder ( $d$ ), the wall thickness of the outer cylinder ( $t$ ), the length of the outer cylinder ( $L$ ) and material were recorded for each sample.
2. Each sample was inserted into a strap and either end of the strap was securely held in the Instron® jaws.
3. The strain gauges were connected to a strain indicator and balanced to read zero with no load.
4. A uniaxial tensile test was begun at a rate of 1 mm/min.

5. At approximately equal load increments a strain reading was recorded. The load at the moment of the strain reading was indicated by marking it directly onto the strip chart. The exact load was read from the chart after the test was completed.
6. The test was stopped at approximately 75% of the estimated yield load.

## Results

The plots of each sample are shown in Figures 9 - 13. Numbered samples were tested for failure; lettered samples were testes for linearity. The excitation voltage of the strain indicator was 2.00 V

Sample	A	B	C	D	E
Length, mm (in)	25.375 (0.999)	25.425 (1.001)	25.324 (0.997)	25.298 (0.996)	25.400 (1.000)
Thickness, mm (in)	1.016 (0.040)	2.032 (0.080)	1.676 (0.066)	1.803 (0.071)	1.727 (0.068)
Gauge Resistance	350 $\square$	350 $\square$	1000 $\square$	350 $\square$	1000 $\square$
Configuration	Full Bridge	Full Bridge	$\frac{1}{2}$ Bridge	$\frac{1}{2}$ Bridge	$\frac{1}{2}$ Bridge
M-M Product #	EA-13-050TG-350	EA-13-050TG-350		EA-13-050TG-350	
Centre Cylinder Diameter	1.27 mm (0.050in)	1.27 mm (0.050in)	1.27 mm (0.050in)	1.27 mm (0.050in)	1.27 mm (0.050in)

Table C1: Table of Sensor Configuration

## Conclusions

With the correct configuration the StrapSensor™ is capable of accurately measuring forces. A full Wheatstone Bridge (Samples A & B) showed the most linear results. These two samples also had a strong correlation between the Instron® and static force results. Samples C & E showed reasonably linear results however there was no correlation between the Instron® and static force results. This variation may be due to insufficient excitation voltage for the 1 M $\square$  gages. Since lower resistant 350  $\square$  gages had sufficient sensitivity, sensors with higher resistance gages are not necessary. Due to the erratic result for Sample D it was concluded the gages on the sample were damaged or connected incorrectly.

Generally samples with thicker walls appear to be more desirable since they were able to withstand forces up to almost 300 N. Sample A, the sample with the thinnest wall thickness, was not strong enough to withstand the necessary forces without damage. A minimum wall thickness of 2 mm or a stronger material is recommended.

In all cases, the ‘force out’ from the Instron® test showed some non-linearity until 40 - 45 N were applied. At this point there is a discontinuity; the slope of the force displacement curve momentarily flattened and then the curve became linear. It is suspected the before the zero slope the insert has yet to seat in the tube and the zero slope is the insert jamming.

## Appendix D: Discontinuity Tests

### Objective

The objective of this test was to determine the mechanism for the discontinuity consistently observed between 40 and 45 N. Various tests were used to examine different possible mechanisms.

### Procedure

1. The diameter of the insert cylinder (d), the wall thickness of the outer cylinder (t), the length of the outer cylinder (L) and material were recorded for each sample.
2. Each sample was inserted into a strap and either end of the strap was securely held in the Instron<sup>®</sup> jaws.
3. The jaws were moved apart at a rate of 10 mm/min until the ‘seating point’ was exceeded. The ‘seating point’ is indicated by a small period of zero force increase on the Instron<sup>®</sup> output.
4. The jaws were moved together until the strap had a small amount of tension in it.
5. There jaws were then moved apart again at a rate of 10 mm/min past the original seating point. It was observed whether or not the sensor seated again.
6. Steps 5 & 6 were repeated 4 times.

### Results

Sample	A1	A2	S1	S2	S3
Length (in)	0.994	1.001	1.004	1.003	1.002
Length (mm)	25.2476	25.4254	25.5016	25.4762	25.4508
Thickness (in)	0.065	0.080	0.065	0.065	0.064
Thickness (mm)	1.651	2.032	1.651	1.651	1.6256

Table D1: Sample Dimensions

	Increasing Average		Decreasing Average	
<b>A1 1.94” Insert</b>	4.43 kg	43.46 N	4.44 kg	43.58 N
<b>A1 0.249” Insert</b>	4.42 kg	43.36 N	4.47 kg	43.80 N
<b>A1 0.300” Insert</b>	4.59 kg	45.03 N	4.40 kg	43.14 N
<b>A2 0.194” Insert</b>	5.17 kg	50.74 N	3.93 kg	38.50 N
<b>A2 0.249” Insert</b>	5.30 kg	51.99 N	3.85 kg	37.77 N
<b>A2 0.300” Insert</b>	4.14 kg	40.64 N	4.32 kg	42.33 N
<b>S1 0.249” Insert</b>	4.20 kg	41.20 N	N/A kg	N/A N
<b>S2 0.249” Insert</b>	4.20 kg	41.20 N	N/A kg	N/A N
<b>S3 0.249” Insert</b>	5.00 kg	49.05 N	N/A kg	N/A N
<b>Strap 1 Only</b>	4.62 kg	45.35 N	4.57 kg	44.83 N
<b>Strap 2 Only (~ 6” length)</b>	4.70 kg	46.11 N	4.45 kg	43.65 N
<b>Strap 2 with Bar Sensor</b>	5.02 kg	49.22 N	4.23 kg	41.45 N
<b>Strap 2 (~2.5’ length)</b>	4.80 kg	47.09 N	N/A kg	N/A N
<b>Total Average</b>	<b>4.66 kg</b>	<b>45.73 N</b>	<b>4.29 kg</b>	<b>42.12 N</b>
<b>Total Standard Deviation</b>	<b>0.381 kg</b>	<b>3.74 N</b>	<b>0.250 kg</b>	<b>2.45 N</b>

Table D2: Discontinuity Points

## Conclusions

The observed discontinuity in the stress strain curve is not a characteristic of the StrapSensor. There was a discontinuity at approximately 43 N regardless of sensor type, material type or length of strap. Even if a sensor was not present the discontinuity was observed.

A strap acts as a very stiff spring. At least three characteristics contribute to strap stiffness; the material properties of the yarn, the pattern of the weave and the sample length. If the discontinuity was due to tightening the weave to the point where the stiffness of the strap changed, increasing the number of woven loops to be tightened by loading a longer length of strap should shift the load at which the discontinuity occurs. As shown in Table 7, there was no significant difference between the discontinuity load for the 0.5 and the 2.5 foot lengths.

It was not possible to confirm whether the discontinuity was due to the specific Instron<sup>®</sup> used as a second Instron was not available at this time to test this hypothesis.



## Appendix E: Repeatability Tests

### Objective

The objective of this test was to demonstrate each sensor has repeatable and predictable linear force-strain curve. This test also examines the extent of hysteresis that occurred to determine if it introduced a large error.

### Procedure

1. The apparatus was weighed. The StrapSensor™ to be tested was inserted into the strap and attached to the strain indicator.
2. The strain indicator was set to the appropriate strain gauge factor and bridge configuration.
3. The strain gauge indicator was then zeroed with the StrapSensor™ unloaded.
4. The bucket assembly was then attached. The complete test set up is shown (Figure 8).
5. The strain reading was recorded.
6. Mass was gradually added to the bucket and the strain reading was recorded with each mass addition until an appropriate mass was reached.
7. Mass was gradually removed from the bucket and the strain reading was recorded with each mass removed.<sup>2</sup>
8. Once all the mass is removed the strain is recorded with the bucket empty and with the strap slackened.
9. One trial consists of several loading, unloading cycles without removing the sensor from the strap or zeroing the strain indicator.
10. Two trials were performed on each sensor

### Results

All the 316 stainless steel sensors showed a strongly linear force – strain curve. The results from each sensor were summarized in Table 8. The global average error was 6.33%. The  $R^2$  value for the 316ss sensors ranged from 0.991 to 0.994. As expected, the 2” long sensors showed a slope approximately half that of the 1” sensors.

---

<sup>2</sup> Note: It is important that the mass is continuously increased or decreased. Increasing the mass by removing one mass and replacing it by double the mass and vice versa for decreasing the mass, will not give accurate results of the hysteresis.

Sample	Length (in)	Average Slope ( $\mu\epsilon/N$ )	Average % Error
P2	1.00	11.049	8.02
P3	1.00	11.450	8.74
P4	1.00	10.967	5.57
P5	1.00	10.844	6.17
P6	1.00	11.247	5.20
P7	2.00	5.7407	6.76
P8	2.00	5.562	6.15
P9	1.00	11.533	5.09
P10	1.00	10.974	5.26

Table E1: Calibration of 316 Stainless Steel Sensors

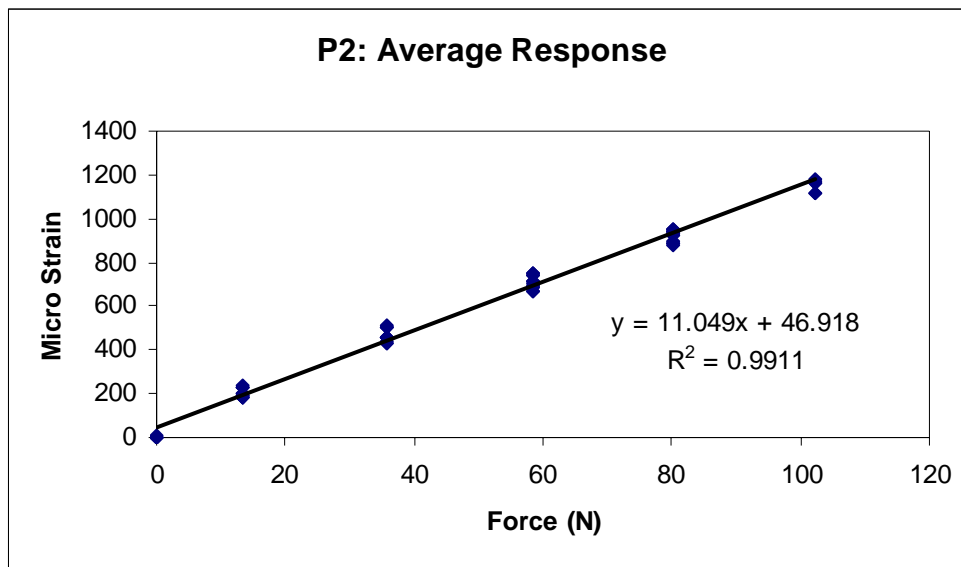

Figure E1: Typical Stress Strain Response over Ten Load - Unload Cycles

Additional stress-strain and hysteresis plots for all prototype sensors can be found in Appendix G.

## Conclusions

The sensors showed a linear force-strain response. Each sensor has been calibrated and can be used for data acquisition in the future. The error for each sensor is largely due to the non-linearity during the initial loading. When using the sensors, they should be inserted into a strap then load cycled a few times before unloading the strap and zeroing the transducer. This initial loading ensures that the strap has seated in the sensor. This will greatly reduce changes in the sensor output between subsequent loading cycles. In some trials this was not done and the data from that cycle was not included in the analysis. The sensors showed a limited and repeatable hysteresis.

## **Appendix F: Invention Disclosure Form**

### **INVENTION DISCLOSURE FORM**

Attached is a form to be used for reporting an invention to your institution's Technology Transfer Office. Please complete by providing the information in the spaces provided. If additional space is required please add additional sheets. Disks are available at these offices for ease of use in completing this form.

You are advised to consult with your Technology Transfer Office informally to discuss your invention and to make certain you are aware of your institution's Intellectual Property Policy.

This document is not an assignment. It simply provides a disclosure of your invention. This disclosure will be held in confidence. You are encouraged to inform your Department Head of this Invention Report so that he/she can corroborate the date of the invention.

Please send the completed form to:

PARTEQ Innovations  
Room 1625  
Biosciences Complex  
Queen's University

Please provide the following information:

1. **INVENTOR(S)**

A. *University*

Name	Dept.	Faculty	Phone
<u>Susan A. Reid,</u>	<u>School of Physical and Health Education,</u>	<u>Arts and Science</u>	<u>(613) 533-2658</u>
<u>Gerald A. B. Saunders,</u>	<u>Department of Surgery,</u>	<u>Faculty of Medicine</u>	<u>(613) 548-3232 x4222</u>

B. *Residence*

Name	Address	Phone
<u>Susan A. Reid,</u>	<u>52 Oakridge Avenue, Kingston ON, K7L 4S9</u>	<u>(613) 547- 4430</u>
<u>Gerald A. B. Saunders</u>	<u>1018 Cliff Side Lane, RR1 Sydenham ON, K0H 2T0</u>	<u>613) 376-9993</u>

## 2. INVENTION

Brief description, and sketches where appropriate, of your proposal under the following headings:

- a. What is the problem addressed by your proposal?

**Enables measurement of tension in flexible strapping, cable or woven material.**

- b. How may it be approached according to present knowledge?

**Strap tension load cells where the belt weaves through a frame holding a series of 3 pins, the centre pin being internally strain gauged. This type of transducer clamps onto the strap, covering all sides of the strap. Alternatively, an external load cell can be attached to the end of the belt.**

- c. Limitations or drawbacks of currently available apparatus, product or process

**Current strap tension load cells clamp onto a strap, requiring the transducer frame to cover some part of all sides.**

**These transducers also have multiple surfaces that require either precision machining or multiple production steps. As well, maintaining linearity of response and controlling friction effects can limit accuracy.**

- d. What is your proposal? (You may attach a draft paper if it describes the invention)

**Please see Sketches 1 and 2 on page F-11.**

**This proposal pertains to an easily insertable transducer for determining the tension in any flexible strap, a woven membrane or a cable. The transducer rides on only one side of the webbing, leaving one side clear of obstruction. This allows the strap or membrane to lie flat against underlying surface. It employs a novel attachment method that does not require any modification or damage to the material being instrumented. The carrier material for the strain gauges is made from a section of tubing. A slot is cut along the length of the carrier material. The material to be instrumented is folded back onto itself. This is inserted into the slot on the carrier. A centre-locking pin is then inserted into the loop formed by the folded material. This pin locks the material inside the carrier tube, preventing the loop from pulling out of the slot. As tension in the material increases, the edges of the slot are pulled open. This creates pure bending in the tube. The maximum bending stresses occur on the centreline of the tube, 90° away from the slit. Strain gauges applied in this location can measure the bending stress. Bending stress will increase linearly as the tension in the flexible material increases.**

**By varying the materials and geometry of the carrier tube (diameter and wall thickness), a large range of transducer sizes and sensitivities can be created using standard industry tubing sizes.**

e. What is thought to be novel in your proposal?

Single side access, transducer requires only one side  
**Small footprint compared to existing technologies**  
**Design simplicity requires minimal machining of components**  
**Non-destructive/ non-disruptive to the material being monitored**  
**Easily inserted and removed.**

f. Has the apparatus, product or process been made or tested?

Yes \_\_\_√\_\_\_ No \_\_\_\_\_

If yes, does a sample or model of your product exist?

Yes \_\_\_√\_\_\_ No \_\_\_\_\_

If so, will it be preserved and made available for demonstration if patent action is proceeded with?

Yes \_\_\_√\_\_\_ No \_\_\_\_\_

If not, why not?

If appropriate,

Is there biological material available for deposit?

Yes \_\_\_\_\_ No \_\_\_\_\_

Does anyone else have access to the biological material?

g. Are photographs (print, slides, stereo, motion pictures) available?

Yes.

3. **REFERENCES**

Has a literature search been conducted?

Yes \_\_\_\_\_

No \_\_\_√\_\_\_

If yes, do you consider the search extensive?

Yes \_\_\_\_\_

No \_\_\_\_\_

Has a patent search been conducted?

Yes \_\_\_\_\_

No \_\_\_√\_\_\_

Please provide any known references in published literature or patents relating to the problem or subject.

4. **DISCLOSURE**

A. Has any disclosure to others been made, whether public or confidential, e.g., discussions with collaborators, suppliers, abstracts, journal publications, conference proceedings, seminars, (under)graduate project reports, grant applications, scientific conferences, poster sessions, industry meetings, offers to sell, etc.? If so to whom, when and where?

**Yes, confidential disclosure has been made to the following persons:**

**Dr. John Frim, Head, Environmental & Applied Ergonomics Section, Defence and Civil Institute of Environmental Medicine, (D.C.I.E.M.)**

**Mr. Walter Dyck, Research Scientist, D.C.I.E.M. Disclosure was made in a private meeting February 22, 2001.**

**Disclosure was made to members of the Ergonomics Research Group, School of Physical and Health Education, at Queen's University in early December of 2000. Persons at the confidential meeting were: Dr. Tim Bryant, Department of Mechanical Engineering, Dr. Evelyn Morin, Department of Electrical and Computing Engineering, Dr. Joan Stevenson, School of Physical and Health Education and Lindsay Hadcock, MSc. Candidate, School of Physical and Health Education**

B. Has any disclosure to others been made, whether public or confidential, e.g., discussions with collaborators, suppliers, abstracts, journal publications, conference proceedings, seminars, (under)graduate project reports, grant applications, scientific conferences, poster sessions, industry meetings, offers to sell, etc.? If so to whom, when and where?

**Yes, confidential disclosure has been made to the following persons:**

**Dr. John Frim, Head, Environmental & Applied Ergonomics Section, Defence and Civil Institute of Environmental Medicine, (D.C.I.E.M.)**

**Mr. Walter Dyck, Research Scientist, D.C.I.E.M. Disclosure was made in a private meeting February 22, 2001.**

**Disclosure was made to members of the Ergonomics Research Group, School of Physical and Health Education, at Queen's University in early December of 2000. Persons at the confidential meeting were: Dr. Tim Bryant, Department of Mechanical Engineering, Dr. Evelyn Morin, Department of Electrical and Computing Engineering, Dr. Joan Stevenson, School of Physical and Health Education and Lindsay Hadcock, MSc. Candidate, School of Physical and Health Education.**

C. Is there, within the next six months, a meeting of a learned society or deadline for publication of a scientific journal to which you plan to make disclosure? If so, when and where?

**No.**



5. **SUPPORT RECEIVED**

A. **FINANCIAL**

Give names of all the financial contributors, including sponsors of research contracts and grants, where relevant.

**Research Contract #PWGSC W7711-0-7632/A with the Defence and Civil Institute of Environmental Medicine, Department of Defense, Canada.**

B. **OTHER**

Has a proprietary material been used at any time during the experimental process or development?

Yes \_\_\_\_\_ No

If Yes, has a Material Transfer Agreement been executed?

Yes \_\_\_\_\_ No \_\_\_\_\_

Has a proprietary database been used at any time during the experimental process or development?

Yes \_\_\_\_\_ No \_\_\_\_\_

If Yes, was a License to use the database executed?

Yes \_\_\_\_\_ No \_\_\_\_\_

## 6. APPLICATIONS AND COMMERCIALIZATION

A. Please describe where or how your apparatus, product or process may be used.

**This “spring” sensor could be used in any strap to provide load-bearing status, e.g. it is possible to monitor critical restraining straps for the transport industry to detect either dangerously high or dangerously low (broke/loose) conditions.**

**There may be applications where the load history of strapping to determine the number of load cycles (fatigue failure monitoring) or instances of overloading.**

**They could be used for monitoring automobile seatbelts during crash testing. They could be used to ensure that the seatbelts are sufficiently taut (i.e. currently car manufactures are using sensors in the intelligent car to monitor the weight of front seat passengers and determine how aggressively to fire the airbags). Perhaps to ensure that child restraints are tightened appropriately.**

**They could also be attached into membranes (sheets) of materials to monitor strain within the material.**

**The configuration of the outer slotted tube can be modified for use in-line on cables.**

B. Do you have any direct contact with, or can you suggest, any commercial enterprise which might be interested in pursuing commercialization of your invention? If so, please elaborate.

**There are a large number of established companies who make load measuring transducers. They include:**

**Massload Technologies, Ph: 1 306 242 2020 Fax: 1 306 931 1991  
301 - 47Str. E  
Saskatoon, Saskatchewan  
Canada  
S7K 5H2**

**Novatech Measurements Limited, Novatech Measurements Limited, +44 1424 852744  
83 Castleham Road  
St Leonards on Sea  
East Sussex  
TN38 9NT  
England**

**BLH Electronics, Inc. (781) 821-2000  
75 Shawmet Road,  
Canton, MA,  
USA, 02021,**

**Entran Devices, Inc. Tel (888) 8-ENTRAN, (973) 227-1002, Fax (973) 227-6865  
10 Washington Ave.,  
Fairfield, NJ 07004-3877, USA**

7. **FURTHER WORK**

Do you expect to continue work toward improving the apparatus, product or process?  
Please elaborate.

**Yes, D.C.I.E.M. has provided initial funding to develop working prototypes, under contract #PWGSC W7711-0-7632/A.**

**INVENTORS:**

Signature(s) \_\_\_\_\_  
\_\_\_\_\_  
\_\_\_\_\_  
\_\_\_\_\_

Name(s) \_\_\_\_\_  
\_\_\_\_\_  
\_\_\_\_\_  
\_\_\_\_\_

Date \_\_\_\_\_

**Acknowledgement of Head(s) of Department(s) {Required}:**

I have read and understand this Report of an Invention

Signature(s) \_\_\_\_\_  
\_\_\_\_\_

\_\_\_\_\_  
Name and Appointment  
\_\_\_\_\_  
Name and Appointment

Date \_\_\_\_\_

Comments:

## Supporting Figures

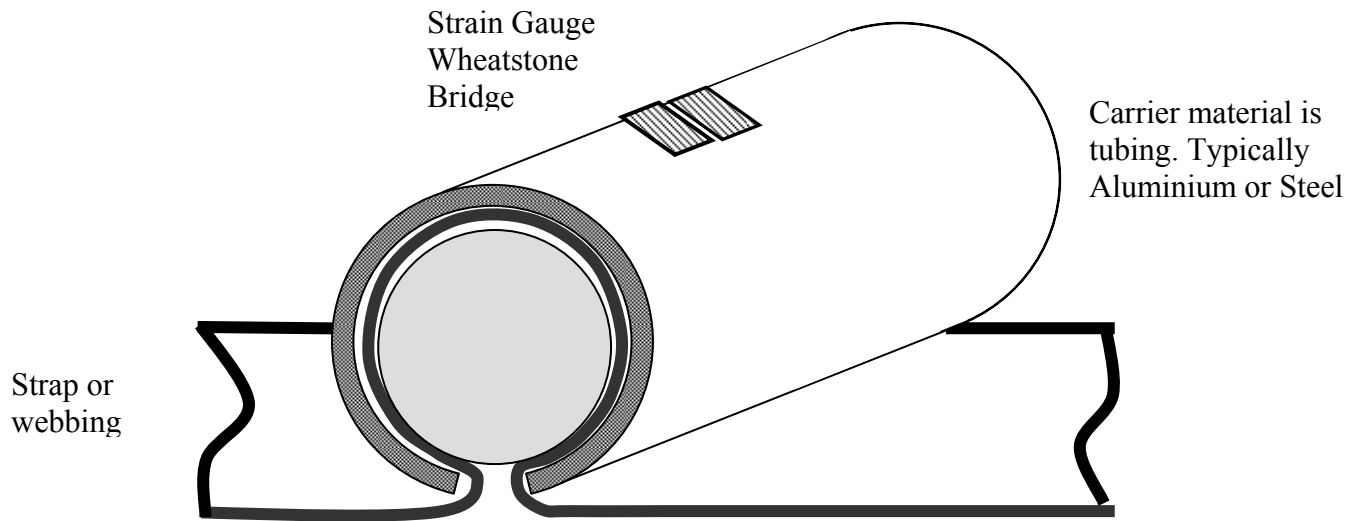

Sketch 1 – overall view of spring sensor installed in a strap.

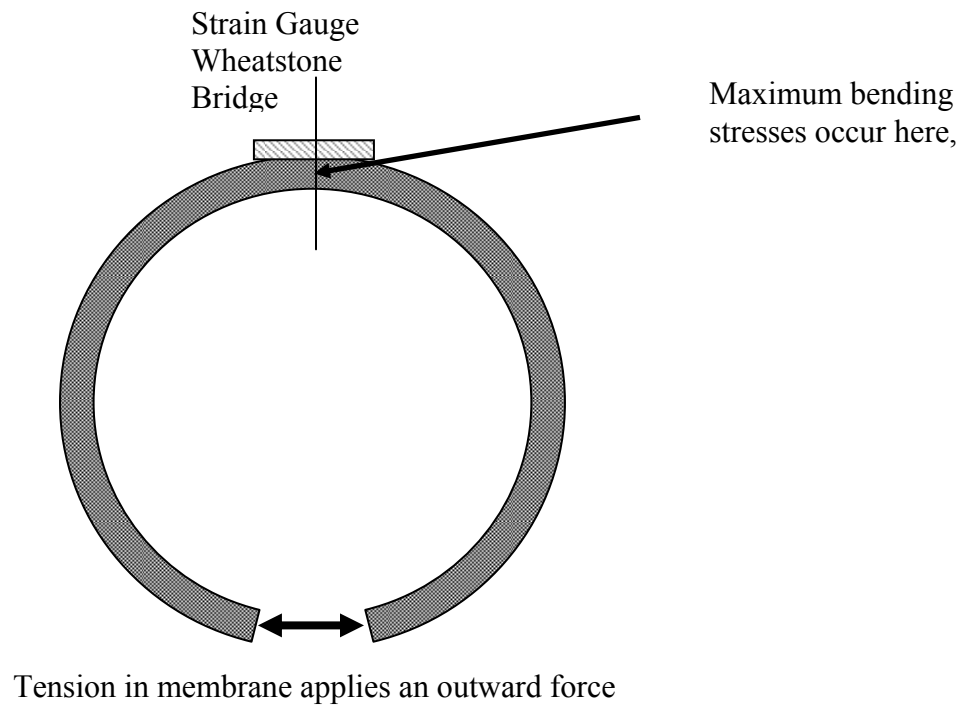

Sketch 2 – End View

## Appendix G: Plots

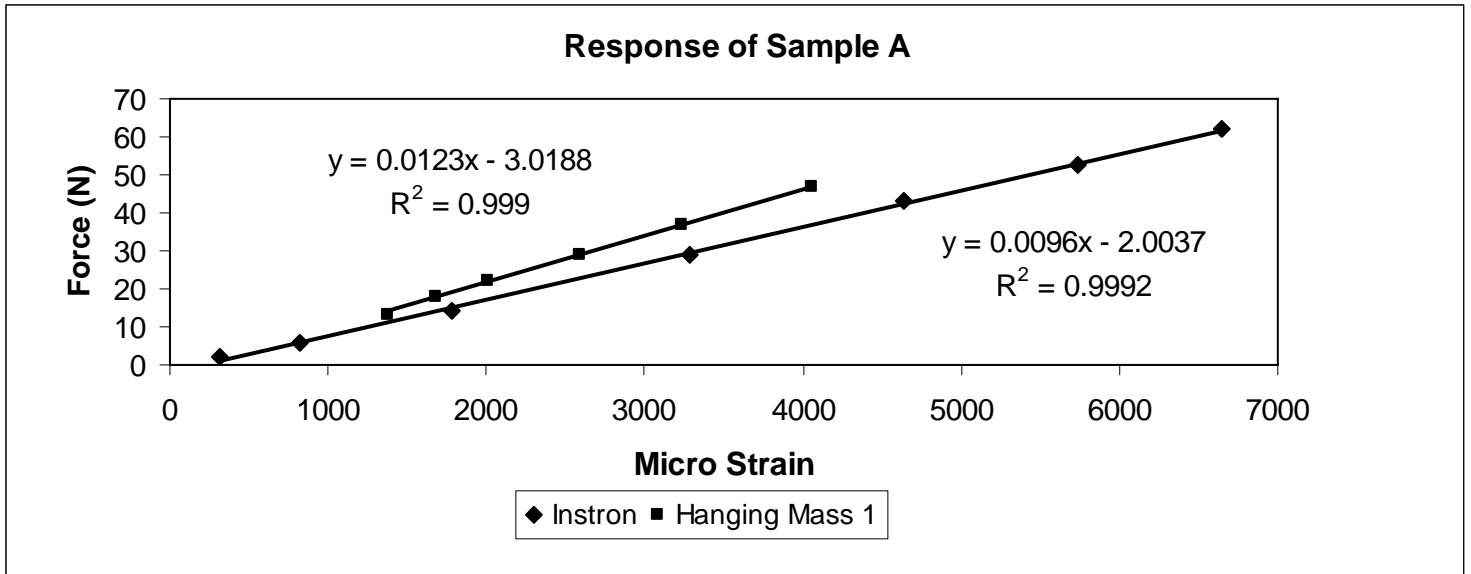

Figure G1: Sample A, Al 6061-T (1", 350Ω , full bridge, t=1.016 mm)

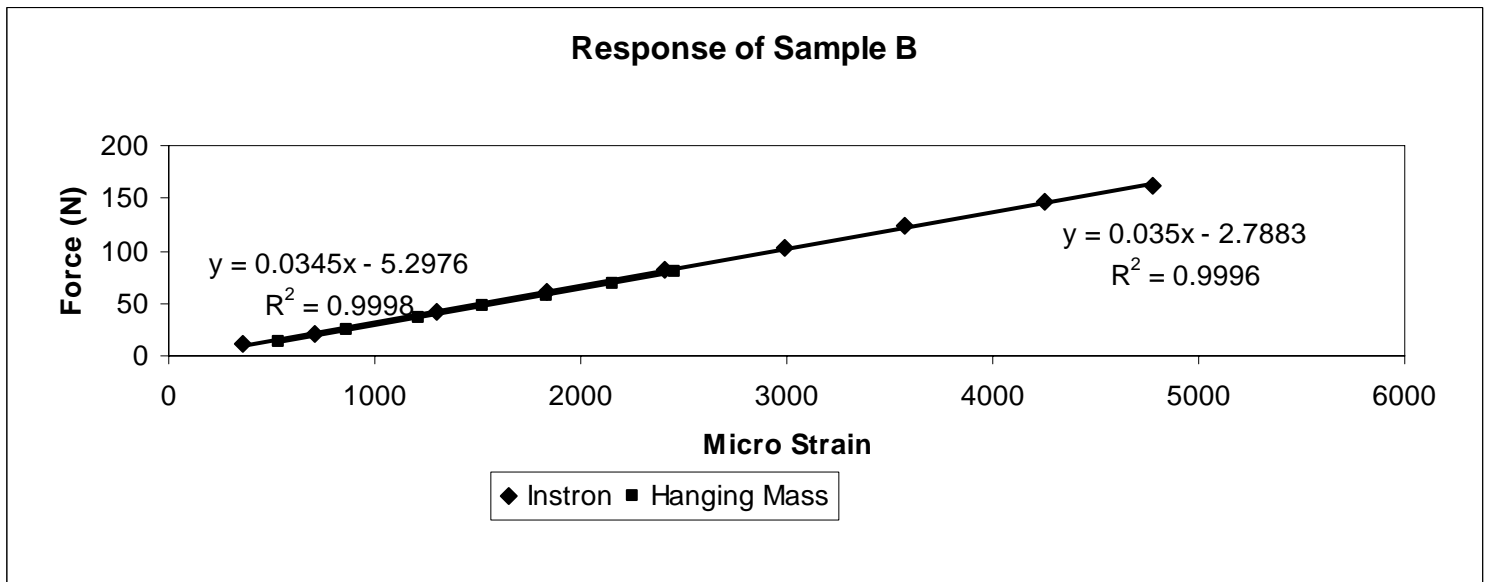

Figure G2: Sample B, Al 6061-T6, (1", 350Ω , full bridge, t=2.032mm)

All subsequent transducers were based on this geometry of blank and 350 Ω, in a full bridge.

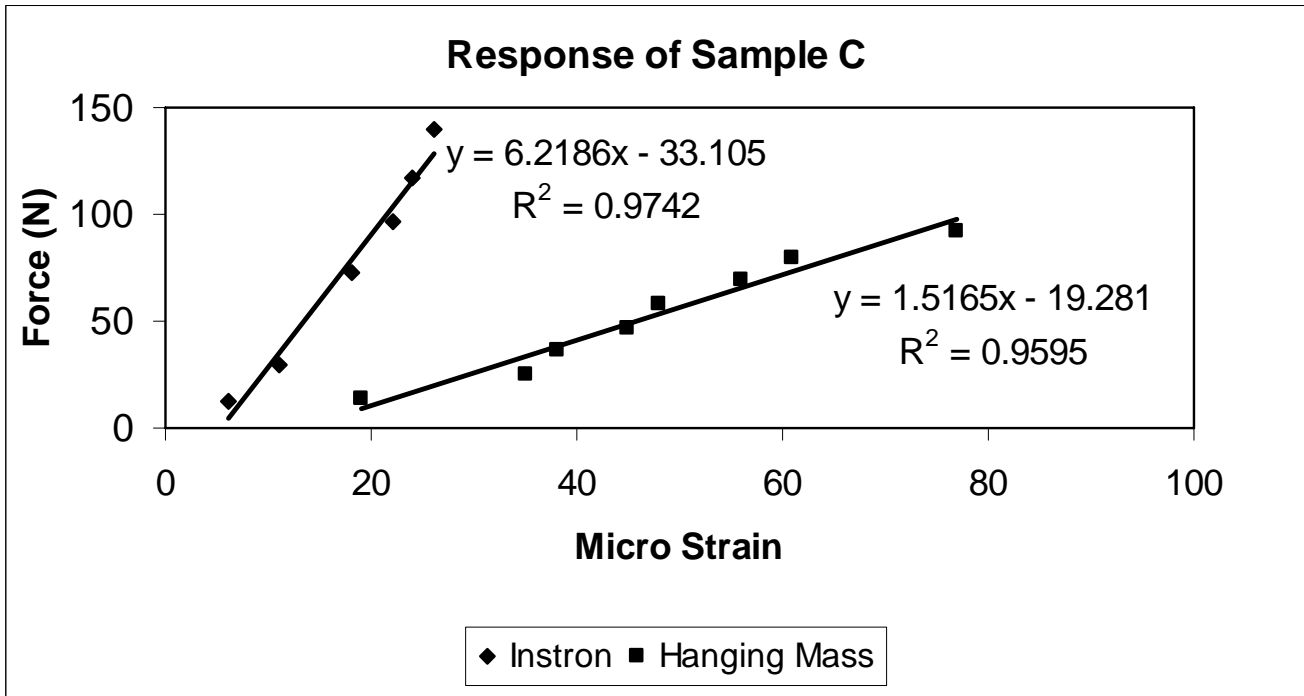

Figure G3: Sample C, Al 6061-T6, (1000 Ω, half bridge, t=1.676 mm)

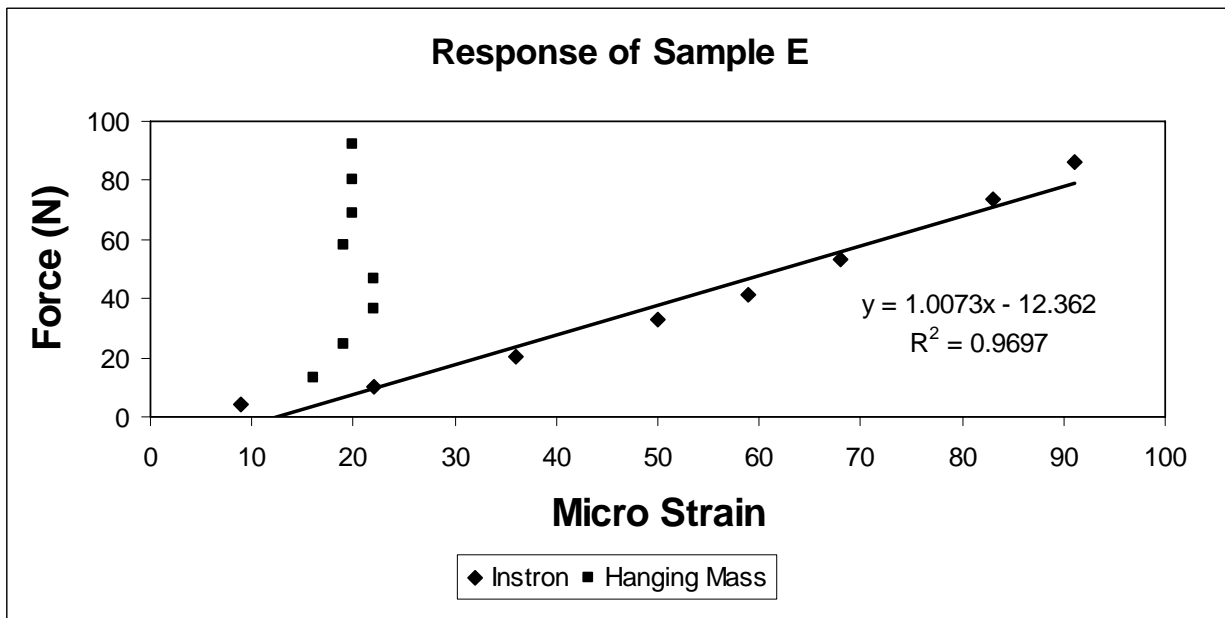

Figure G4: Sample E, Al 6061-T6, (1", 350Ω, half bridge, t=1.727)

Note: plastic failure occurred during static testing.

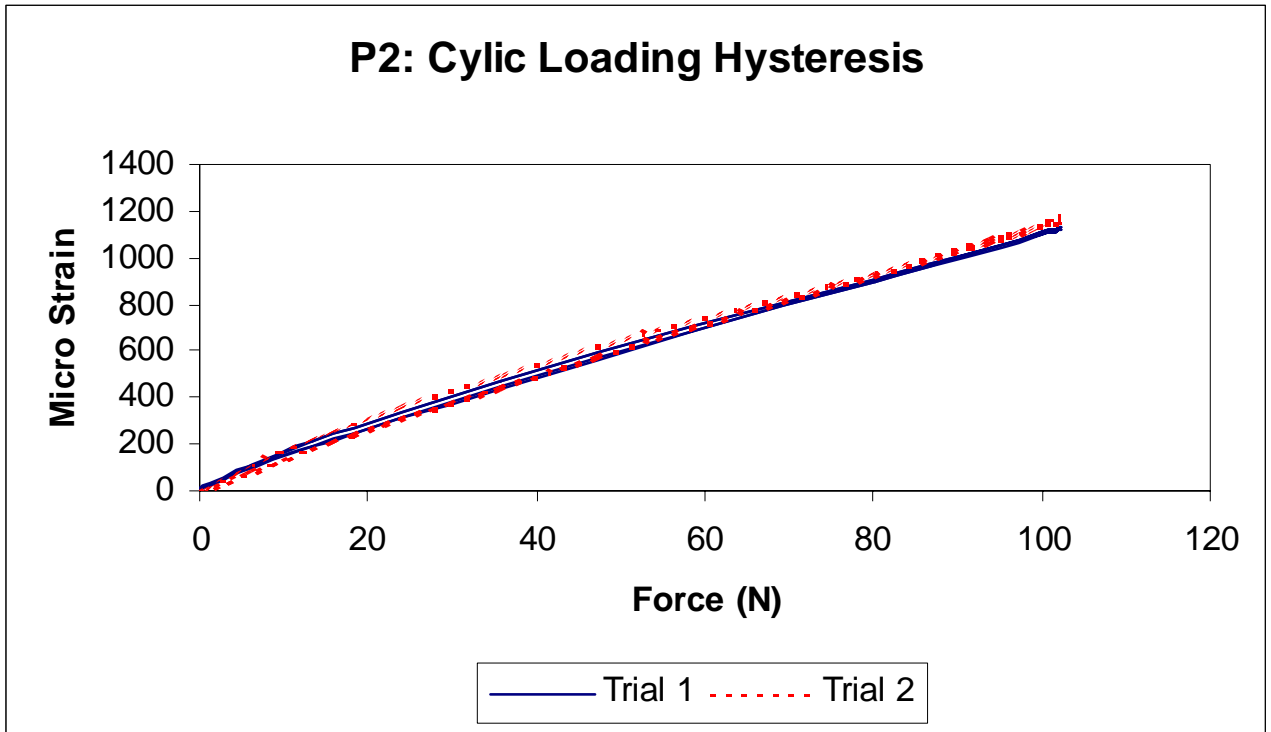

Figure G5: P2, 316ss Cyclic Loading Hysteresis (for 1" strap)

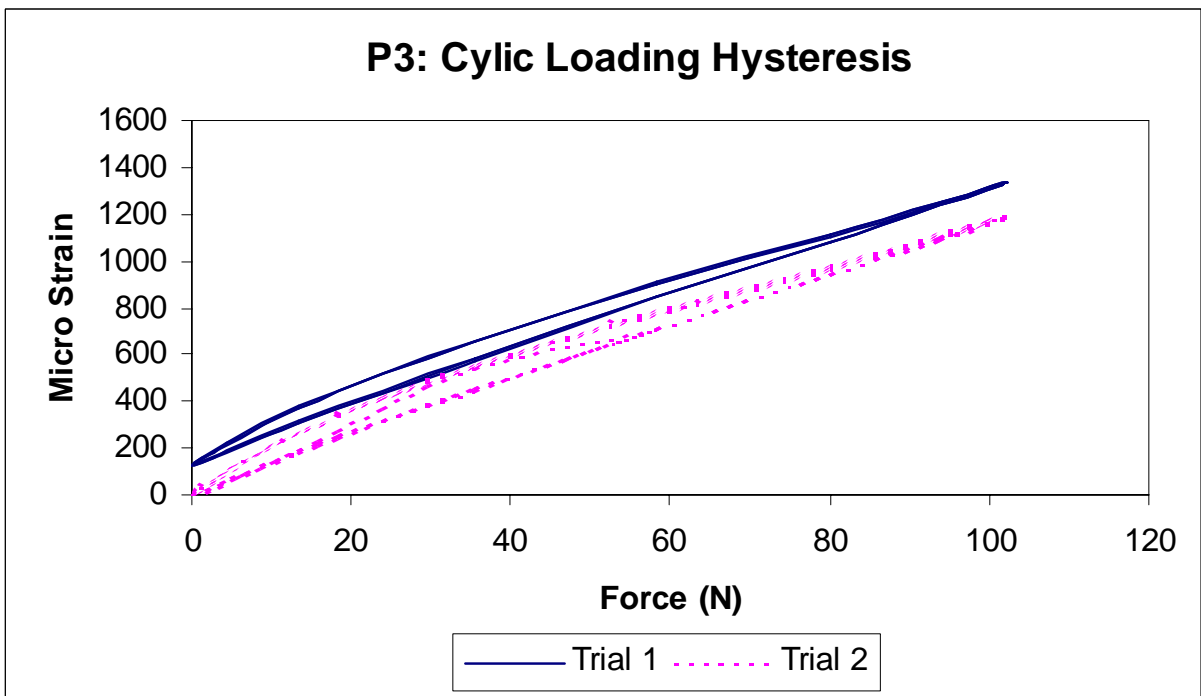

Figure G6: P3, 316ss, Cyclic Loading Hysteresis (for 1" strap)



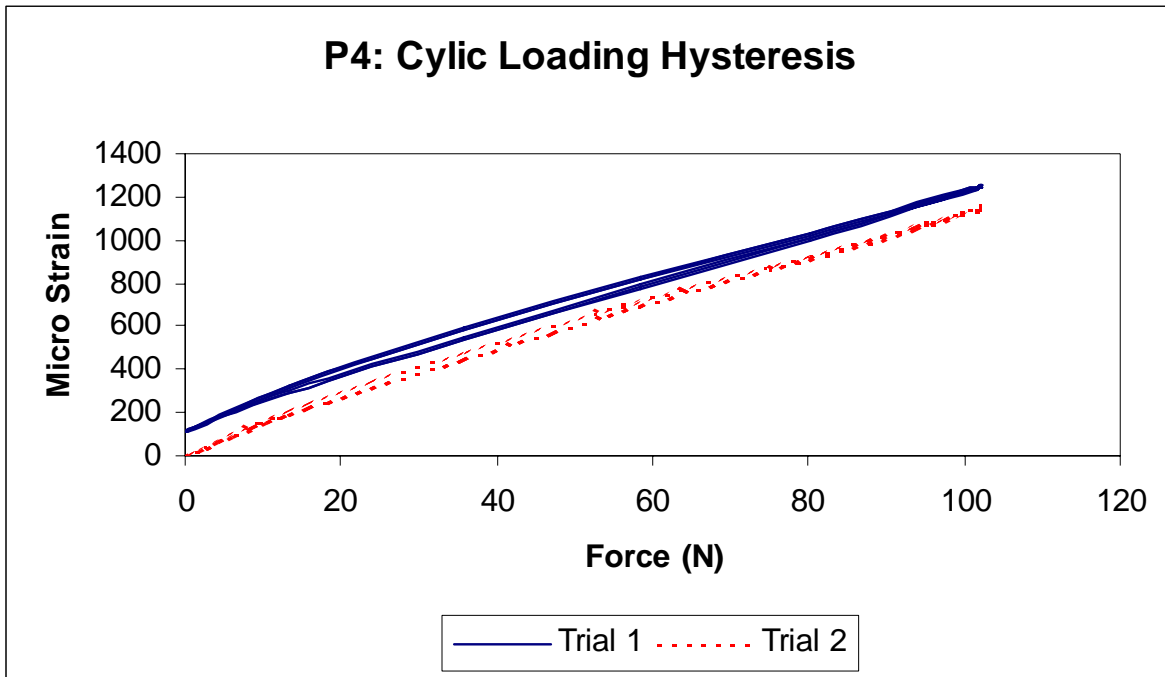

Figure G7: P4, 316ss Cyclic Loading Hysteresis (for 1" strap)

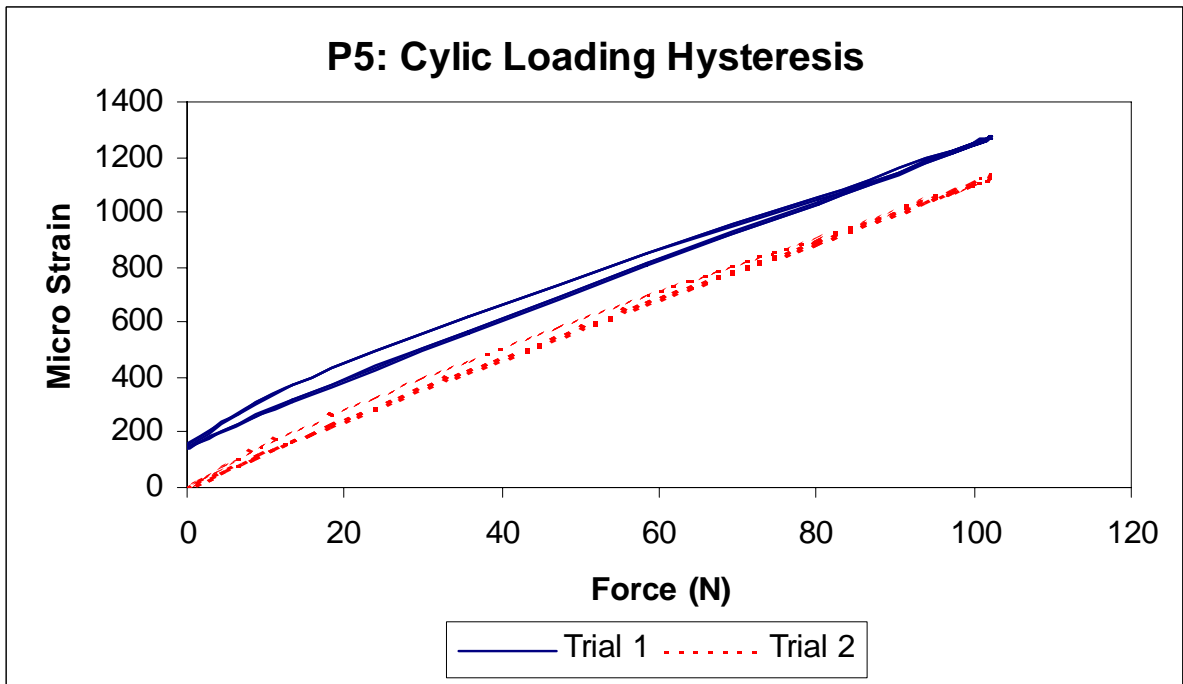

Figure G8: P5, 316ss, Cyclic Loading Hysteresis (for 1" strap)

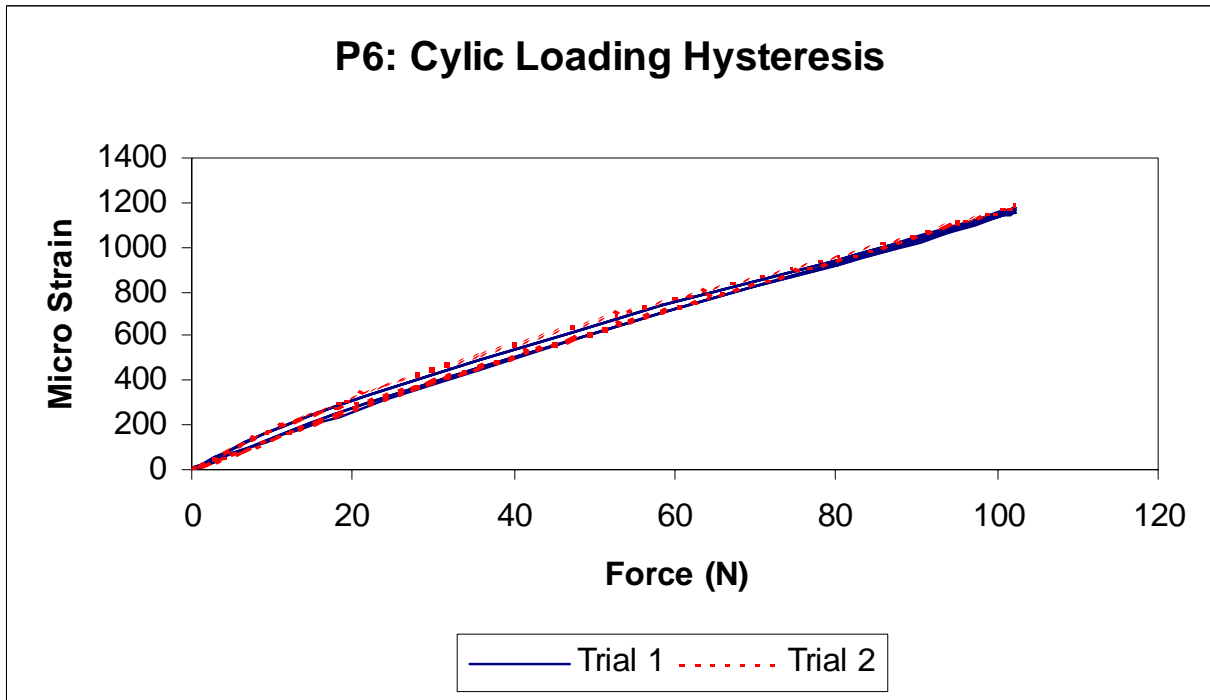

Figure G9: P6, 316ss Cyclic Loading Hysteresis (for 1" strap)

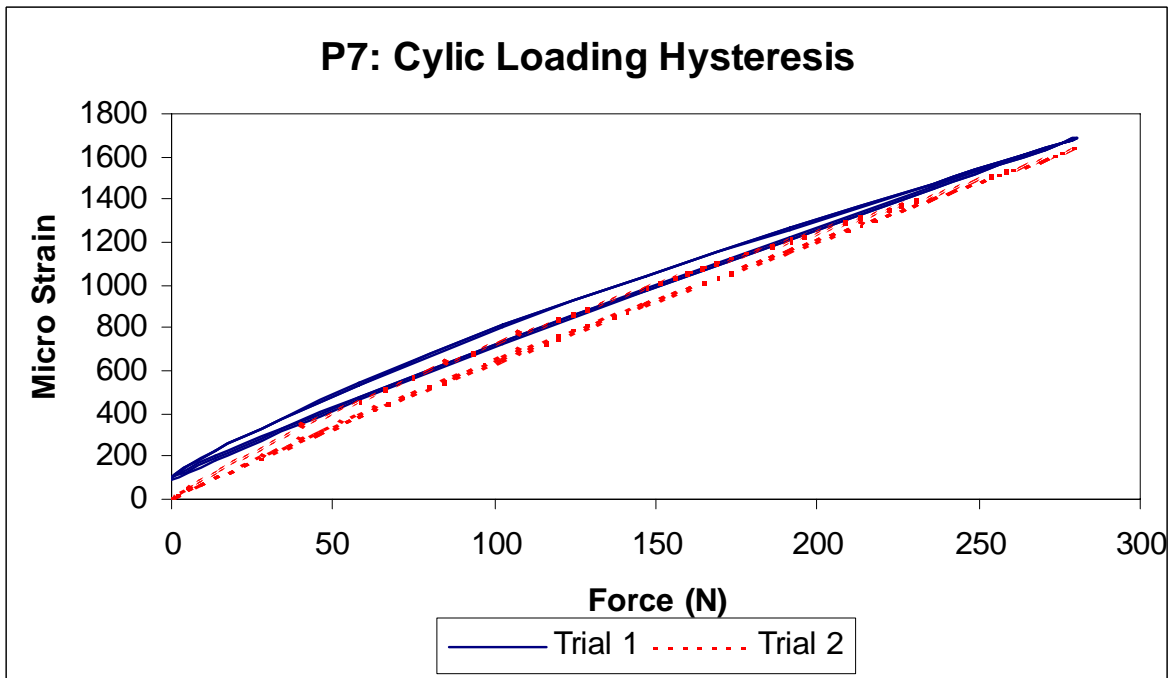

Figure G10: P7, 316ss Cyclic Loading Hysteresis (for 2" strap)

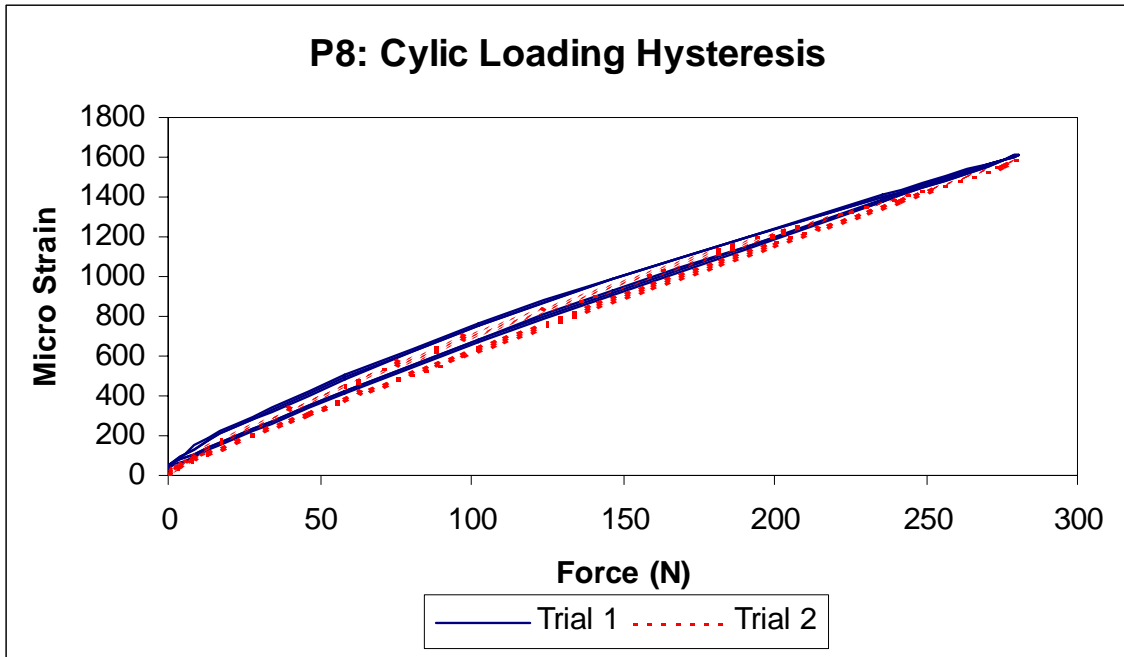

Figure G11: P8, 316ss Cyclic Loading Hysteresis (for 2" strap)

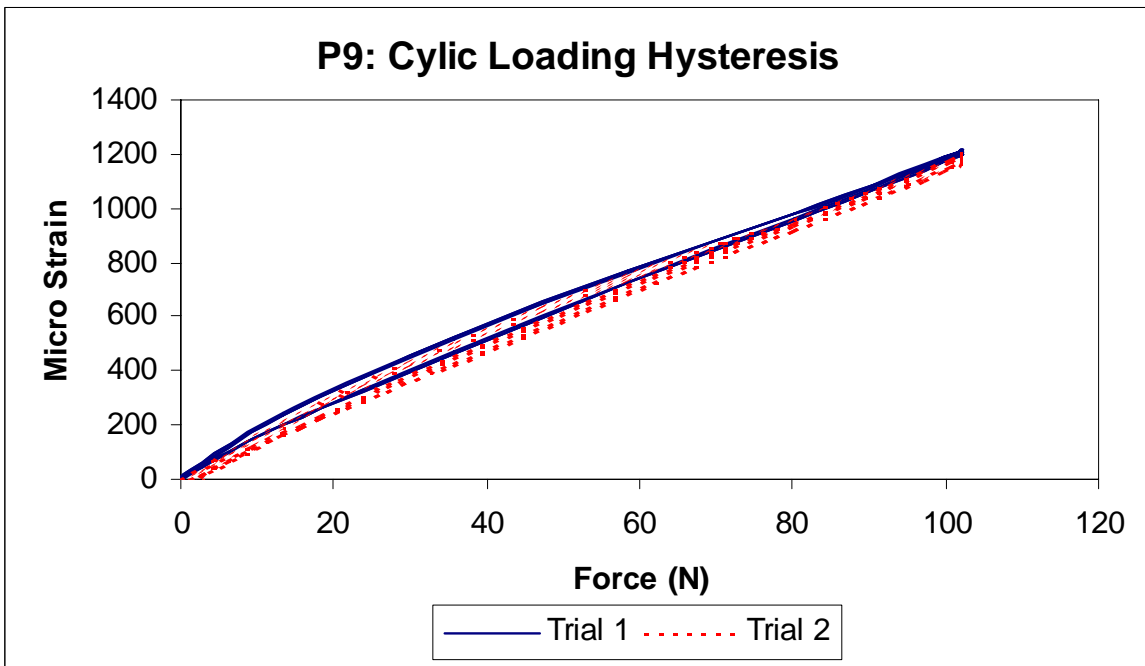

Figure G12: P9, 316ss Cyclic Loading Hysteresis (for 1" strap)

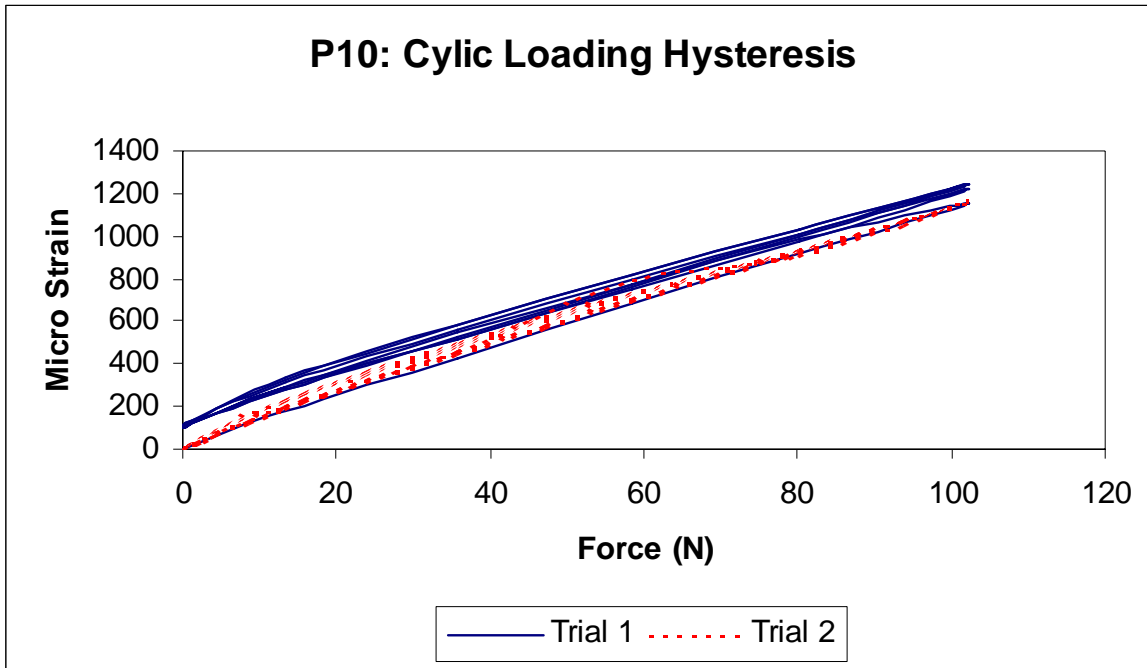

Figure G13: P10, 316ss Cyclic Loading Hysteresis (for 1" strap)

## **Appendix H: Previous US Patent of Similar Device**

A formal patent search was undertaken and only one device similar to the new strap force sensors was found. For information, the expired US patent #3,817,093 of Williams (1974) is attached.

# UNCLASSIFIED

<b>DOCUMENT CONTROL DATA</b> <small>(Security classification of the title, body of abstract and indexing annotation must be entered when the overall document is classified)</small>		
<b>1. ORIGINATOR</b> (The name and address of the organization preparing the document, Organizations for whom the document was prepared, e.g. Centre sponsoring a contractor's document, or tasking agency, are entered in section 8.)  Publishing: DRDC Toronto Performing: Ergonomics Research Group–Human Mobility Research Centre, Queen's University, Kingston, Ontario K7L 3N6 Monitoring: Contracting: DRDC Toronto		<b>2. SECURITY CLASSIFICATION</b> <small>(Overall security classification of the document including special warning terms if applicable.)</small>  <b>UNCLASSIFIED</b>
<b>3. TITLE</b> (The complete document title as indicated on the title page. Its classification is indicated by the appropriate abbreviation (S, C, R, or U) in parenthesis at the end of the title)  <b>Development of a Dynamic Biomechanical Model for Load Carriage: Phase II Part A: Initial Development of a Novel Strap Tension Sensor (U)</b>		
<b>4. AUTHORS</b> (First name, middle initial and last name. If military, show rank, e.g. Maj. John E. Doe.)  <b>S.A. Reid; G.A.B. Sanders; J.A. Good; J.T. Bryant; J.M. Stevenson</b>		
<b>5. DATE OF PUBLICATION</b> <small>(Month and year of publication of document.)</small>  <b>August 2005</b>	<b>6a NO. OF PAGES</b> <small>(Total containing information, including Annexes, Appendices, etc.)</small>  <b>46</b>	<b>6b. NO. OF REFS</b> <small>(Total cited in document.)</small>  <b>1</b>
<b>7. DESCRIPTIVE NOTES</b> (The category of the document, e.g. technical report, technical note or memorandum. If appropriate, enter the type of document, e.g. interim, progress, summary, annual or final. Give the inclusive dates when a specific reporting period is covered.)  <b>Contract Report</b>		
<b>8. SPONSORING ACTIVITY</b> (The names of the department project office or laboratory sponsoring the research and development – include address.) Sponsoring: Tasking:		
<b>9a. PROJECT OR GRANT NO.</b> (If appropriate, the applicable research and development project or grant under which the document was written. Please specify whether project or grant.)  <b>12CM03</b>	<b>9b. CONTRACT NO.</b> (If appropriate, the applicable number under which the document was written.)  <b>W7711-0-7632-02</b>	
<b>10a. ORIGINATOR'S DOCUMENT NUMBER</b> (The official document number by which the document is identified by the originating activity. This number must be unique to this document)  <b>DRDC Toronto CR 2005-118</b>	<b>10b. OTHER DOCUMENT NO(s).</b> (Any other numbers under which may be assigned this document either by the originator or by the sponsor.)	
<b>11. DOCUMENT AVAILABILITY</b> (Any limitations on the dissemination of the document, other than those imposed by security classification.)  <b>Unlimited distribution</b>		
<b>12. DOCUMENT ANNOUNCEMENT</b> (Any limitation to the bibliographic announcement of this document. This will normally correspond to the Document Availability (11). However, when further distribution (beyond the audience specified in (11) is possible, a wider announcement audience may be selected.))  <b>Unlimited announcement</b>		

**UNCLASSIFIED**

## UNCLASSIFIED

### DOCUMENT CONTROL DATA

(Security classification of the title, body of abstract and indexing annotation must be entered when the overall document is classified)

13. **ABSTRACT** (A brief and factual summary of the document. It may also appear elsewhere in the body of the document itself. It is highly desirable that the abstract of classified documents be unclassified. Each paragraph of the abstract shall begin with an indication of the security classification of the information in the paragraph (unless the document itself is unclassified) represented as (S), (C), (R), or (U). It is not necessary to include here abstracts in both official languages unless the text is bilingual.)

(U) This work was undertaken in support of the DLR research thrust "Development of a Dynamic Biomechanical Load Carriage Model". This document details the design and development of a novel transducer (StrapSensorÔ) that can be attached to a flexible membrane or strap to measure material tension. The transducer achieves an exceptionally small footprint (<13 mm) and can be inserted into any strap on conventional Load Carriage (LC) systems to record strap tensions. No modification to the surface is required for attachment and it is readily repositioned. A variety of load ranges can be accommodated using the same transducer theory. The device demonstrated a highly linear response ( $R2 = 0.98 - 0.99$ ) and low repeatable hysteresis (<6.5% error over multiple load-unload cycles).

This is a potentially exploitable technical development and formal disclosure has been made to protect any intellectual property arising from this work. Initial patent searches have discovered an expired patent on a related similar device and further exploration is being made to determine if this new device is a "substantive " improvement and subsequently remain patentable. Opportunities (other than by patenting) may exist for commercialization by protecting aspects of this device as a Registered Industrial Design.

14. **KEYWORDS, DESCRIPTORS or IDENTIFIERS** (Technically meaningful terms or short phrases that characterize a document and could be helpful in cataloguing the document. They should be selected so that no security classification is required. Identifiers, such as equipment model designation, trade name, military project code name, geographic location may also be included. If possible keywords should be selected from a published thesaurus, e.g. Thesaurus of Engineering and Scientific Terms (TEST) and that thesaurus identified. If it is not possible to select indexing terms which are Unclassified, the classification of each should be indicated as with the title.)

(U) Load carriage; Dynamic Biomechanical Model; Novel Strap Tension Sensor; transducer

UNCLASSIFIED