

DEFENCE RESEARCH ESTABLISHMENT  
ATLANTIC

PROPELLER DESIGN STUDIES FOR THE  
ACOUSTIC RESEARCH SHIP C.F.A.V. QUEST



RESEARCH AND DEVELOPMENT BRANCH  
DEPARTMENT OF NATIONAL DEFENCE  
CANADA

D.R.E.A. REPORT 81/2

**DEFENCE RESEARCH ESTABLISHMENT ATLANTIC**

9 GROVE STREET

P.O. BOX 1012  
DARTMOUTH, N.S.  
B2Y 3Z7

TELEPHONE  
(902) 426-3100

**CENTRE DE RECHERCHES POUR LA DÉFENSE ATLANTIQUE**

9 GROVE STREET

C.P. 1012  
DARTMOUTH, N.É.  
B2Y 3Z7

---

**RESEARCH AND DEVELOPMENT BRANCH  
DEPARTMENT OF NATIONAL DEFENCE  
CANADA**

DEFENCE RESEARCH ESTABLISHMENT  
ATLANTIC

DARTMOUTH N.S.

D.R.E.A. REPORT 81/2

PROPELLER DESIGN STUDIES FOR THE  
ACOUSTIC RESEARCH SHIP C.F.A.V. QUEST

L. J. Leggat      J. Th. Ligtelijn\*      J. L. Kennedy

August 1981

Approved by T. Garrett, Director/Technology Division

DISTRIBUTION APPROVED BY



CHIEF D.R.E.A.

RESEARCH AND DEVELOPMENT BRANCH  
DEPARTMENT OF NATIONAL DEFENCE  
CANADA

\* The Netherlands Ship Model Basin  
Wageningen, The Netherlands

## ABSTRACT

CFAV QUEST is a specially designed quiet ship used for underwater acoustic research at the Defence Research Establishment Atlantic. QUEST was commissioned in 1969, however, advances in sonar technology since that time have required additional silencing of the ship propellers. As a result, a joint propeller design and model test program was undertaken with the Netherlands Ship Model Basin.

The shortcomings of the present propellers are described and a comparison is given between model and full scale propulsion results. The design criteria and techniques used for a new set of propellers are reviewed, and the suitability of the new propellers is assessed in relation to propulsion and cavitation criteria. Further, the effect on propeller performance and cavitation of modifying the shaft support from a bossing to an A-bracket is examined.

ETUDE SUR LA CONCEPTION DES HELICES DU NAVIRE DE RECHERCHE  
ACOUSTIQUE QUEST

L.J. Leggat, J. Th. Ligtelijn et J.L. Kennedy

RESUME

Le CFAV QUEST, navire auxiliaire des Forces Canadiennes, a été conçu spécialement pour naviguer en silence, pour la recherche acoustique sous-marine au Centre de Recherches pour la Défense Atlantique. Le QUEST a été lancé en 1969. Cependant, les progrès de la technologie du sonar ont nécessité une atténuation supplémentaire du bruit des hélices de navires. On a donc établi un programme de conception et d'essai sur maquette des hélices en collaboration avec le Bassin de Conduite des Navires des Pays-Bas.

Les points faibles des hélices actuelles sont décrits et comparés en fonction des résultats obtenus avec la maquette et ceux des essais en grandeur réelle. Les critères de conception et les techniques utilisés pour une nouvelle série d'hélices sont revus, et les nouvelles hélices sont réévaluées en fonction de la propulsion et de la cavitation. De plus, on étudie l'effet que l'adoption d'une chaise en A comme support d'arbre, au lieu d'un bossage, aurait sur les performances et la cavitation.

## TABLE OF CONTENTS

	<u>Page No.</u>
ABSTRACT	ii
NOTATION	v
1. INTRODUCTION	1
2. PRE-DESIGN TESTING	2
3. ANALYSIS OF THE EXISTING PROPELLER	2
4. PROPELLER DESIGN	3
5. MODEL TESTING	6
5.1 Open Water Tests	6
5.2 Propulsion Tests	6
5.3 Cavitation Tests	7
5.4 Comparison of Calculated and Test Results	7
6. A-BRACKET CONDITION	8
7. CONCLUDING REMARKS	9
TABLE I	11
ILLUSTRATIONS	12
REFERENCES	20
DOCUMENT CONTROL DATA	23

## NOTATION

- $C_A$  - model-ship correlation allowance
- $C_T$  - thrust loading coefficient  $C_T = \frac{T}{\frac{1}{2}\rho V^2 \frac{\pi}{4} D^2}$
- $D$  - propeller diameter
- $J$  - advance coefficient of propeller
- $K_Q$  - torque coefficient
- $K_T$  - thrust coefficient
- $n$  - propeller rotation rate
- $P_D$  - delivered horsepower
- $P_E$  - effective horsepower
- $P_\infty$  - static pressure
- $P_v$  - vapour pressure of water
- $t$  - thrust deduction fraction
- $T$  - propeller thrust
- $V$  - ship speed
- $V_x$  - axial wake velocity component
- $w_s$  - ship wake fraction
- $w_m$  - model wake fraction
- $X$  - dimensionless propeller radius
- 
- $\eta_P$  - propeller efficiency in open water
- $\eta_R$  - relative rotative efficiency
- $\rho$  - density of water
- $\sigma_n$  - cavitation number based on RPS:  $\sigma_n = \frac{P_\infty - P_v}{\frac{1}{2}\rho n^2 D^2}$

## 1. INTRODUCTION

Effective underwater acoustic research requires a research vessel with very low levels of self and radiated noise. To accomplish this end, special attention must be directed at the design stage toward the reduction of ship machinery and propeller noise. Thus, for the Canadian Forces Auxiliary Vessel (CFAV) QUEST, the Defence Research Establishment Atlantic's underwater acoustic research vessel, extreme care was exercised in the detailed design and construction of the ship to minimize noise and vibrations so that the ship-radiated noise level would be the lowest possible within the limits of existing technology<sup>1</sup>. Special arrangements were made for mounting machinery, piping, and trunking; and the provision of acoustical bulkheads. Further, techniques of reduced noise propeller design were employed to provide a quiet propeller at speeds below seven knots; the speed range of interest for acoustic research, when the vessel was commissioned<sup>2</sup>. Construction of CFAV QUEST was completed early in 1967. More than ten years after completion, the acoustic features incorporated in the design make the ship one of the quietest diesel electric surface ships afloat today.

The propulsion machinery in QUEST consists of a diesel electric system with two main diesel generators. In addition, a gas turbine driven generator, mounted in an acoustically isolated compartment, provides propulsion during quiet operations such as drifting and steaming below seven knots. The ship has twin screws and twin rudders, and the propeller shafts are supported by steamlined bossings. The general characteristics of the ship are shown in Figure 1. The present propeller is shown in Figure 2 and will be referred to as Propeller 5349.

Since the design of the QUEST propellers in 1964 by the National Research Council of Canada, designers and researchers have expanded the understanding of methods to control noise and vibration produced by ships' propellers. Techniques of adapting the propeller to the wake and adopting skew to control cavitation and vibration are now better understood. Advances in propeller technology, coupled with a requirement to reduce QUEST's radiated noise signature at speeds above seven knots, led to the initiation of a new propeller design for CFAV QUEST. The Defence Research Establishment Atlantic (DREA) entered into a joint propeller design and model test program with the Netherlands Ship Model Basin (NSMB) under a research contract, which included the use of the NSMB depressurized towing tank so that acoustic measurements could be performed.



The propeller design and model test program was divided into three phases: analysis and testing of the present propeller, and development of design criteria; design and testing of a new propeller; and design and testing of a propeller for QUEST with the bossing replaced by A-brackets. The purpose of this paper is to outline the design and testing processes used and to discuss the degree of success achieved.

## 2. PRE-DESIGN TESTING

Resistance and propulsion tests, and a wake velocity survey were conducted with a 1/10 scale model of the QUEST hull.

The resistance measurements were made over the speed range from 6.5 knots to 16.5 knots. The resistance data scaled to full size for the appended hull are shown in Figure 3. The propulsion test was carried out with NSMB stock propellers for the same speed condition as the resistance test. Measurements were made of propeller thrust and torque, and the residual towing force acting on the captive model. The performance data scaled to full size for ideal trial conditions are presented in Figure 3.

The wake velocities were measured in the port propeller plane at a ship speed of 16.0 knots. The three orthogonal velocity components were deduced from five-hole pitot tube measurements. The axial wake as indicated in Figure 4 demonstrates the large velocity defect behind the shaft bossing and the boundary layer on the hull.

## 3. ANALYSIS OF THE EXISTING PROPELLER

The performance of the existing propellers was analyzed mathematically by both DREA and NSMB. DREA employed the MIT lifting-surface propeller design<sup>3</sup> and analysis<sup>4</sup> programs. NSMB performed a redesign starting with the same inputs provided for the original design and using their lifting-line design method<sup>5</sup>. They completed the analysis by applying their lifting-line<sup>6</sup> and lifting-surface<sup>7</sup> analysis techniques.

The existing propellers were designed for homogeneous flow and on the basis of propulsion tests carried out on a QUEST ship model fitted with stock propellers<sup>2,8</sup>. These tests, performed at a displacement of 1828 tonnes showed that a ship speed of 16.5 knots could be achieved with the available power. To provide a margin against face (pressure-side) sheet cavitation, the propeller design was performed at a value of advance coefficient,  $J$ , 5.5% higher than the  $J$  at maximum ship speed predicted by the model tests<sup>2,8</sup>. This procedure resulted in a design  $J$  of 1.21.

The actual displacement of QUEST is closer to 2221 tonnes. Results of measured mile tests with QUEST<sup>9</sup> show that a maximum speed of slightly over 15 knots is possible. At this full power speed, the advance coefficient is 1.06.

The difference between the operating and design J's and the increase in displacement could lead to an absence of shock free entry of the flow and an increase in the expected propeller loading. This conjecture was supported by the DREA results from the lifting-surface program<sup>3</sup>, which indicated that the propeller's pitch and camber distributions were higher than optimum at the operating J condition in a homogeneous wake.

A propeller design by NSMB, employing their lifting-line design<sup>5</sup> and using the original input data and a homogeneous wake, turned out to be basically the same as the present propeller. Small deviation in cambers and radial load distributions occurred owing to differences in methods used to provide margins against face sheet cavitation.

The QUEST propeller was analyzed at a ship speed of 13 knots using the NSMB lifting-line analysis program<sup>6</sup>, which takes into consideration the three nominal wake velocity components. This speed was of interest because a new propeller design would attempt to produce no noisy sheet cavitation below 13 knots. The results showed that back (suction-side) sheet cavitation occurred readily on the present blades at 13 knots. Maximum cavitation was calculated to occur when the propeller blades passed through the wake peak behind the shaft support bossing. Substantial levels of radiated noise may be associated with the inception and desinence of cavitation in the wake peak.

From the analyses of the QUEST propeller, it was observed that the propeller efficiencies were very high, but that cavitation was present at unacceptably low speeds.

#### 4. PROPELLER DESIGN

With the above information in mind, the goal for the new propellers was established as follows. The propeller was to be free of sheet cavitation up to a ship speed of 13 knots, while maintaining approximately the same efficiency. Lloyds' Ice Class I standards were to be applied. Maximum power and rotation rate were fixed by the characteristics of the installed machinery. The present system develops 1998 kW delivered power at 140 rpm. Analysis of the wake harmonic information showed that a five-bladed propeller would not

produce a coherent match with significant wake harmonics. Therefore the blade number was left unaltered. The propeller diameter was optimal with regard to efficiency.

The design was accomplished using the NSMB lifting-line design<sup>5</sup>. Lifting-line<sup>6</sup> and lifting-surface<sup>7</sup> analysis programs were used to predict the performance of the propeller designs. Three iterations of design and analysis were performed before arriving at a propeller which satisfied the design criteria. The major problem which had to be addressed was the large velocity defect in the axial wake behind the bossing, and its effect on the angle of attack fluctuations. As a result, it was necessary to skew the blade and to alter the blade section thickness distributions.

Skew has a number of beneficial effects. It can delay cavitation inception, especially for face sheet cavitation<sup>10</sup>. Promising results have been obtained in this respect from various other model experiments at the NSMB. Furthermore, skew can reduce the volume velocities and accelerations on the leading edge sheet cavities as the blade passes through the wake, thus reducing the acoustic source strength associated with the cavity fluctuations.

Blade section cavitation buckets can be widened to increase the margin against sheet cavitation by making the section thickness-to-chord ratios larger, however, this measure compromises the margin against bubble cavitation. Wider buckets can be achieved, without sacrificing the margin against mid-chord bubble cavitation, by moving the chordwise position of maximum thickness, from mid-chord toward the leading edge.

The final propeller design, designated 5363 and shown in Figure 5, had some  $60^\circ$  of skew at the tip. The position of maximum thickness on the blade sections was moved from 50 to 30 per cent of chord at the outer radii. At the inner radii, where the cavitation margins were high the maximum thickness was maintained at mid-chord to provide strength near the trailing edge where the highest stresses occur. To accommodate high blade stresses, which were expected to occur during reverse operation, thicknesses were increased by between 4 and 12 per cent over those required to satisfy Lloyds' Ice Class I. This led to an increase in chord length to give optimum thickness-to-chord sections. These increases in chord were also beneficial in reducing effective angle of attack fluctuations, thus reducing the probability of sheet cavitation.

Blade section pitch and cambers were chosen such that no face sheet cavitation was predicted at full power.

The calculated open-water curves for the final design showed that the propeller efficiency was slightly higher than that of the existing propeller. Cavitation analysis of this new propeller showed a slight amount of back sheet cavitation at 12 knots and no pressure-side cavitation.

The strength of this propeller was checked initially at the full power condition using Romson's method<sup>1,2</sup>, and with normal beam theory using the hydrodynamic loading calculated with the lifting-line method<sup>5</sup>. Results showed that the stresses were well within the specified allowable stress for fatigue for a typical propeller alloy, 5.9 kN/cm<sup>2</sup>.

Final checks of the propeller strengths were made using the NSMB and DREA finite element techniques. Both methods developed a three-dimensional finite element model of the propeller blade clamped at the root. The NSMB model is built up from NASTRAN QUAD4 isoparametric membrane-bending elements. The DREA method uses a superparametric curved shell element<sup>14</sup>. In both techniques, the elemental loads are determined from calculated blade pressure distributions. The NSMB specified the hydrodynamic loading using unsteady lifting-surface theory, taking into account the measured wake field. DREA calculated a steady loading using a lifting-surface method<sup>3</sup>. A comparison of stresses calculated for the static mean load condition at full power ahead is shown in Figure 6. This figure indicates a good agreement of the results using the independently developed methods.

Because maximum stresses for highly skewed propellers generally occur in the reverse operating condition, a check of the propeller stresses was made at the astern bollard condition with 1110 kW delivered power per shaft and 140 rpm. The astern power was exaggerated to provide a margin of safety which would include crash astern conditions. The result was a maximum stress of 7.2 kN/cm<sup>2</sup> at 0.7 radius. This value is considered acceptable as stresses of this magnitude rarely occur and are well below the limit of proportionality of the propeller material.

The maximum stress for the full power ahead condition including the effects of unsteady hydrodynamic loading was calculated by the NSMB to amount to 5.9 kN/cm<sup>2</sup> at the blade root. Therefore the propeller strength is deemed acceptable for all operating conditions.

## 5. MODEL TESTING

Both the existing QUEST propeller, and the highly skewed replacement were tested on the 1/10 scale model in the depressurized towing tank at the NSMB. Open water, propulsion, cavitation and noise tests were performed.

### 5.1 Open Water Tests

The open water characteristics of the two propellers are shown in Figure 7. Propeller 5363 is slightly more efficient than propeller 5349. The reason for this increase in efficiency is not entirely understood. However, for lightly loaded propellers, as with QUEST, skew seems to have a beneficial effect on efficiency. This result is consistent with those from a limited number of other tests with lightly loaded propellers carried out at the NSMB.

### 5.2 Propulsion Test

The propulsion test was performed under identical conditions for both sets of propellers at the draft shown in Figure 1. The speed range was from 6.5 to 16.5 knots. All appendages were fitted. The wake scale effect and model-ship correlation allowance were determined according to the NSMB statistics<sup>15</sup>. A model-ship correlation factor,  $C_A$ , of 0.00058 and a wake scaling correlation factor,  $(1-w_s)/(1-w_m)$ , of 1.005 were used. The test results with the original propellers are shown in Figure 8, together with the full scale performance data<sup>9</sup>.

In order to check the selected correlation factors, a correlation study was carried out on the basis of the full scale speed trials<sup>9</sup>. These full scale performance data were corrected for the tested drafts using statistical data<sup>15</sup>. The model test data were then extrapolated to the trial condition with a sea water temperature of 4.4°C. The closest overall agreement between corrected trial data and extrapolated model test results was obtained for a model-ship correlation factor of 0.0006 and a wake scaling correlation factor of 1.03.

It would appear from these propulsion tests, that for equal power absorption, a slightly higher speed can be obtained with the new propellers. Taking into consideration the accuracy of the full scale experimental data and the corrections employed, the agreement between the statistical correlation data and the actual results of the correlation study is considered satisfactory.

### 5.3 Cavitation Tests

Observation of propeller cavitation for the two sets of propellers was carried out in the depressurized towing tank using photo and video equipment to observe back sheet cavitation from inside the ship model and an external periscope to observe face sheet cavitation. During the cavitation tests, electrolysis was applied to the tank water ahead of the propellers in order to supply sufficient cavitation nuclei. Also, carborundum strips with an equivalent sand roughness of 60  $\mu\text{m}$  were applied to the leading edges of the propeller blades to trip the boundary layer, and so reduce scale effects on cavitation inception.

The experiments included finding the cavitation inception points and photographing the back sheet cavitation patterns at selected test conditions. The inception test results for the two propellers are shown in Figures 9 and 10 for the propellers 5349 and 5363 respectively in the behind condition.

The inception of tip vortex cavitation is subject to scale effects owing to the large difference in Reynolds' number between model and full scale. The inception speeds have been corrected for those differences<sup>16</sup>. Other forms of cavitation were taken to be independent of scale effects.

The results of the cavitation tests show that the 5349 propellers fitted to QUEST can be expected to experience back sheet cavitation at speeds above 7.7 knots. Figure 10 shows that propeller 5363 should delay back sheet cavitation inception until a speed of 15.2 knots. With these new propellers, the inception speed for tip vortex cavitation can be expected to rise from 7.9 to 9.9 knots. The radiated noise tests showed that the noise characteristics of the new propellers will be superior to those of the existing ones.

### 5.4 Comparison of Calculated and Test Results

As a number of numerical techniques were employed in the design of these propellers, it is useful to examine their abilities to predict model and full scale performance.

The measured open-water curves and those predicted by two analysis methods are shown in Figure 11 for propeller 5349. The MIT lifting-surface method<sup>4</sup> used by DREA appears to be more prone to over-estimate the efficiency ( $\eta_p$ ), thrust coefficient ( $K_T$ ), and torque coefficient ( $K_Q$ ), at the higher values of  $J$ . The NSMB lifting-line program<sup>6</sup> produced a more accurate estimate, in the region of the design  $J$  of 1.06.

Reasonable comparison of cavitation patterns was achieved between prediction and model test for propeller 5349. Results from the lifting-line calculation<sup>6</sup> and model test for this propeller are compared in Figure 12.

The calculated cavitation patterns for the highly skewed propeller were very much more pessimistic than were actually observed in the model test, as shown in Figure 13. This difference between model tests and calculation is believed to result from errors in the calculated cambers and angles of attack. The NSMB lifting-line analysis program<sup>6</sup> fits polynomials to the available lifting-surface corrections<sup>11</sup>. The corrections calculated in this manner are correct for the majority of propeller geometries. However, for this case, where the propeller is narrow-bladed and highly skewed, lifting-surface correction data are not sufficiently accurate. As a result, the corrections are estimated from extrapolations of the polynomials leading to errors in the calculated cambers and angles of attack.

## 6. A-BRACKET CONDITION

To provide a more homogeneous flow in the propeller plane, an A-bracket arrangement, shown in Figure 14, was substituted for the shaft bossing. A second propeller design was undertaken for this condition; and model testing, similar to that performed on the bossing configuration, was carried out.

The wake survey, Figure 15, for this configuration showed a different wake than that of the bossing configuration. The velocity defect is wider, and not as deep. Changing the shaft support from a bossing to an A-bracket produced a slight reduction in required horsepower. Apparently loss in friction and pressure drag produced by removing the bossing was almost made up with the additional profile drag from the A-brackets. This result is consistent with results obtained from systematic experiments carried out with ship models fitted with bossings and A-brackets<sup>17</sup>.

The propeller design for this case followed the established NSMB design technique<sup>5,6,7</sup>. The span-wise blade loading was altered from that of 5363 to provide an increase in propeller efficiency. This measure would have an adverse effect on the tip vortex inception speed, but little effect on sheet cavitation inception. The result would be an increase in the ship speed with little change in ship noise at full power.

Lifting-line analysis of this latter propeller predicted that the maximum open water propeller efficiency would increase to 75 per cent from 73 per cent with propeller 5363; a significant improvement when one considers the high efficiency already associated with the bossing propeller. The cavitation calculations showed that more back sheet cavitation could be expected. However, the extent was small, and as previously mentioned, the calculated cavitation appeared to be pessimistic for the first set of highly skewed propellers. The A-bracket propeller is shown in Figure 16 and is designated 5413.

The pertinent results of the open water, propulsion, and cavitation inception testing of propeller 5413 are shown in Table 1 along with the results from the other two propellers.

The major improvement in the A-bracket configuration over the bossing lies in the increase in propulsive coefficients at full power. In general, the resistance of the A-bracket configuration is somewhat lower. The main contributions to the improvement are the better propeller efficiency and the more favourable propeller-hull interaction. The latter is caused mainly by a reduced thrust deduction in the A-bracket case.

## 7. CONCLUDING REMARKS

The information in Table 1 shows that the new QUEST propellers for the bossing configuration produce a significant improvement in propeller cavitation performance without an adverse effect on propeller efficiency. This result is achieved by altering pitch, camber, chord and thickness over the original propeller, and by adopting skew. With propeller 5363, tip vortex cavitation is predicted to occur at 9.9 knots and back sheet cavitation at 15.2 knots.

The alternate afterbody arrangement which incorporates A-brackets for shaft support shows an improvement in the wake characteristic in the propeller plane. However, the propeller designed for this configuration shows no improvement in cavitation and noise performance over the propeller 5363 because of the different design criteria. The decision to attempt to increase propeller efficiency by altering the propeller circulation distribution results in a rise in open water efficiency



from 73.3 to 77.8 per cent at the design J. This increase in efficiency, however, is achieved at a cost of approximately one knot in tip vortex cavitation inception speed. Because both hull and propeller efficiency are superior with the A-bracket configuration, the resulting propulsive coefficient for the A-bracket case is 15 per cent above that of the original QUEST propeller.

TABLE 1  
MODEL TEST RESULTS

	<u>5349(bossing)</u>	<u>5363(bossing)</u>	<u>5413(A-bracket)</u>
Ship speed at full power	15.25 kt	15.42 kt	15.86 kt
Propeller rpm at full power	137.3	137.9	139.1
Effective power at 16 kt	1473 kW	1473 kW	1462 kW
Propulsive coefficient, full power	.618	.641	.711
Maximum open water efficiency	.726	.763	.789
Open water efficiency at full power J	.719	.733	.778
$[(1-t)/(1-w)]\eta_R$	.859	.874	.914
Tip vortex cavitation inception	7.9 kt	9.9 kt	9.0 kt
Back sheet cavitation inception	7.7 kt	15.2 kt	15.2 kt

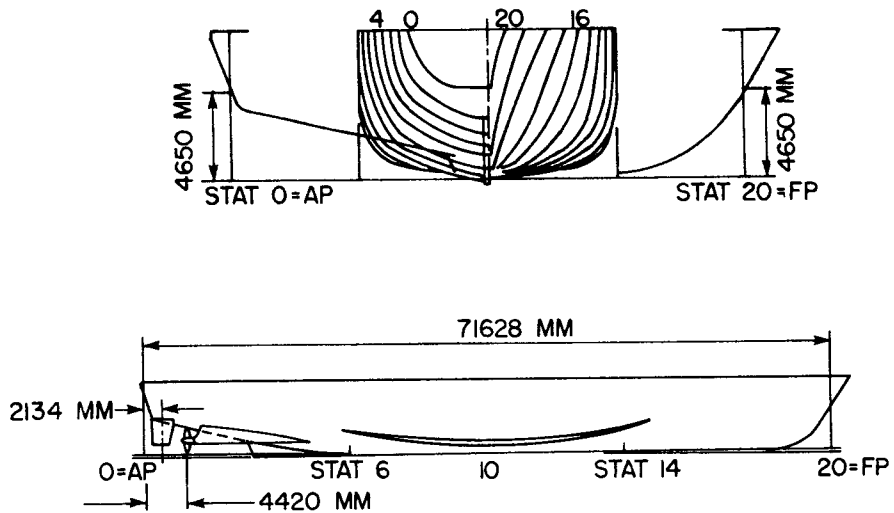

FIG. 1: BODY PLAN, CONTOURS AND APPENDAGE ARRANGEMENT FOR QUEST.

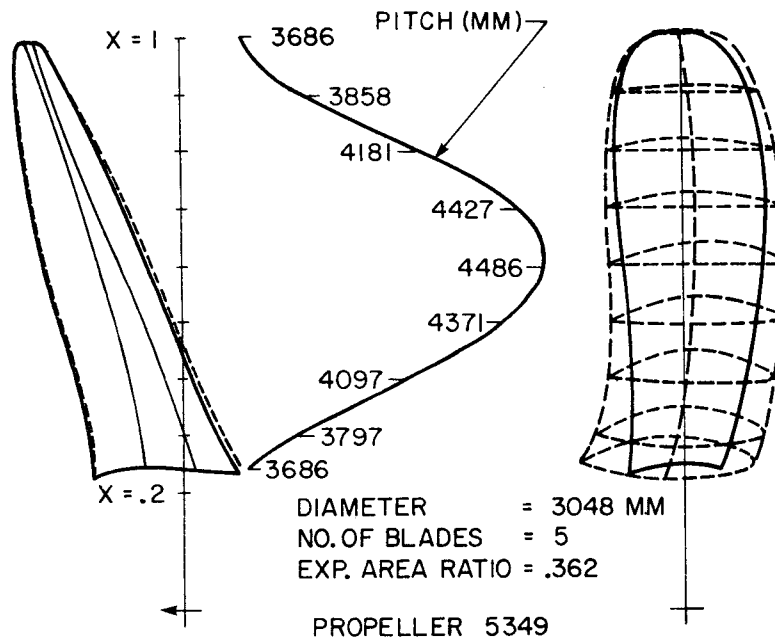

FIG. 2: GEOMETRY OF PRESENT PROPELLERS ON QUEST.

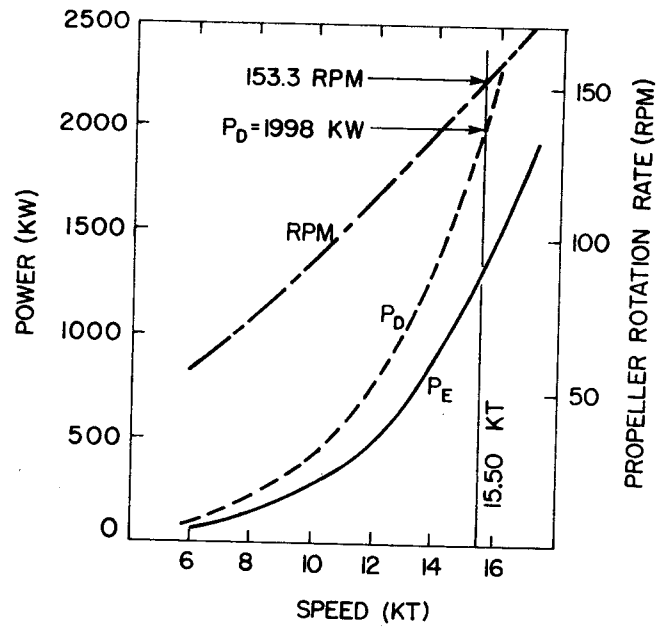

FIG. 3: PROPULSION TEST WITH STOCK PROPELLERS. DRAUGHT, 4650 MM.

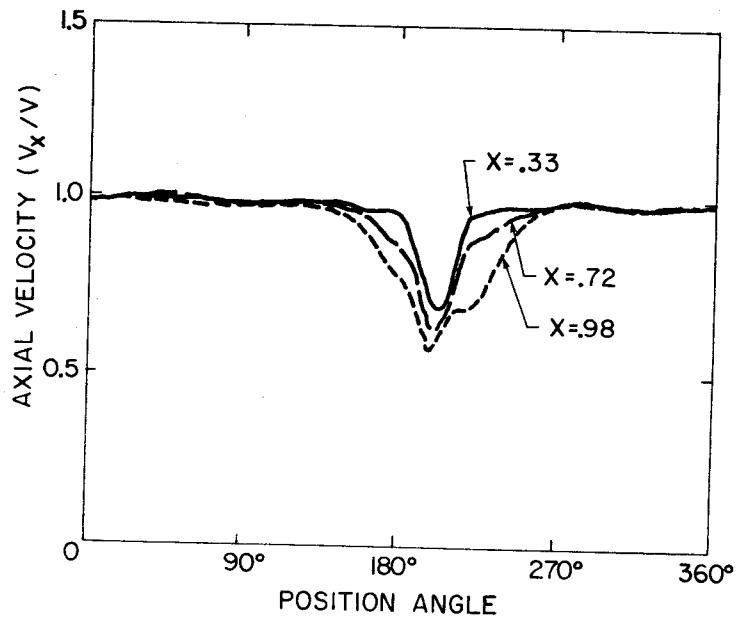

FIG. 4: AXIAL WAKE SURVEY IN PORT PROPELLER PLANE: BOSSING CONFIGURATION.

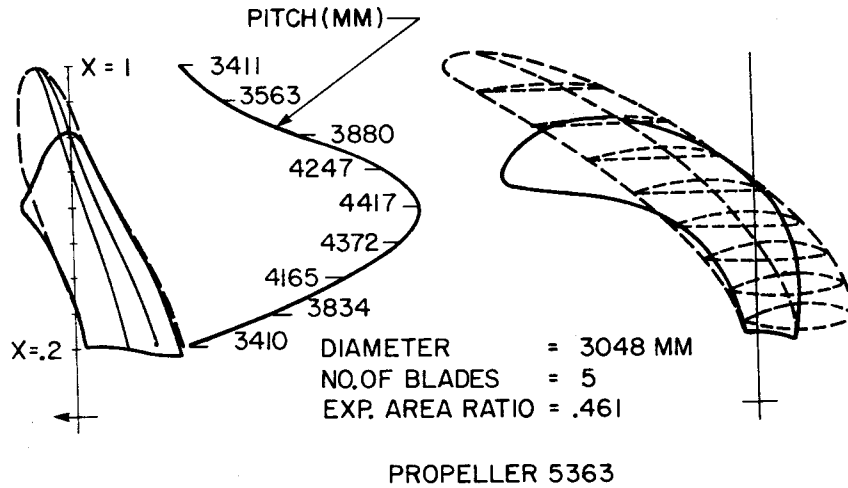

FIG. 5: GEOMETRY OF NEW PROPELLERS FOR QUEST.

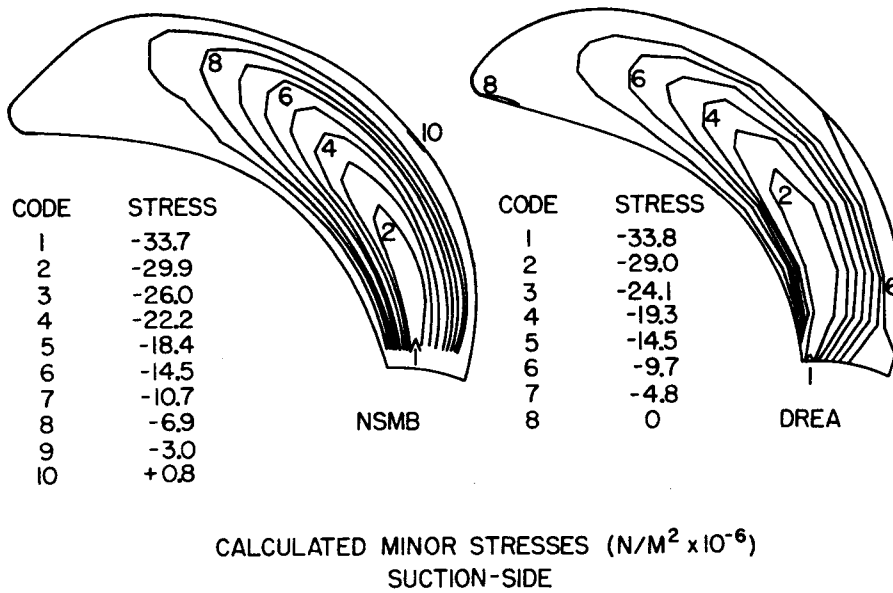

FIG. 6: CALCULATED STRESSES ON PROPELLER 5363 FROM STEADY HYDRODYNAMIC AND CENTRIFUGAL LOAD. AHEAD 15.3 KT 143 RPM.

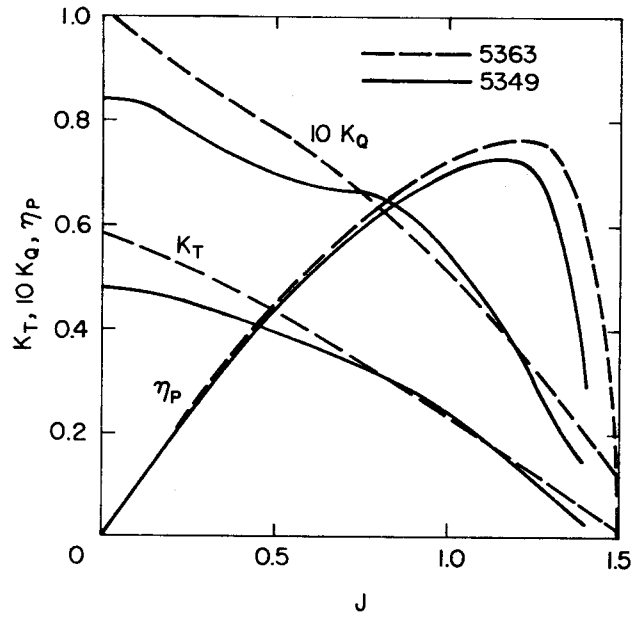

FIG. 7: MEASURED OPEN WATER DATA FOR PROPELLERS 5349 AND 5363.

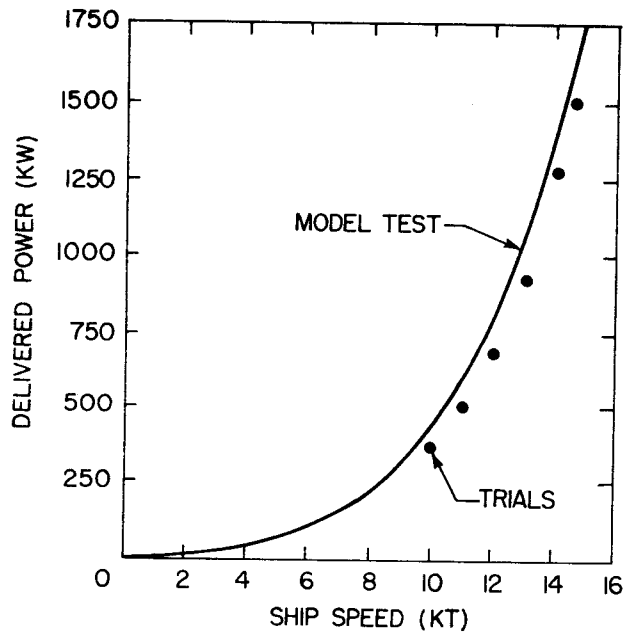

FIG. 8: FULL SCALE AND MODEL PROPULSION RESULTS, PROPELLER 5349. DRAUGHTS, 4650 MM.

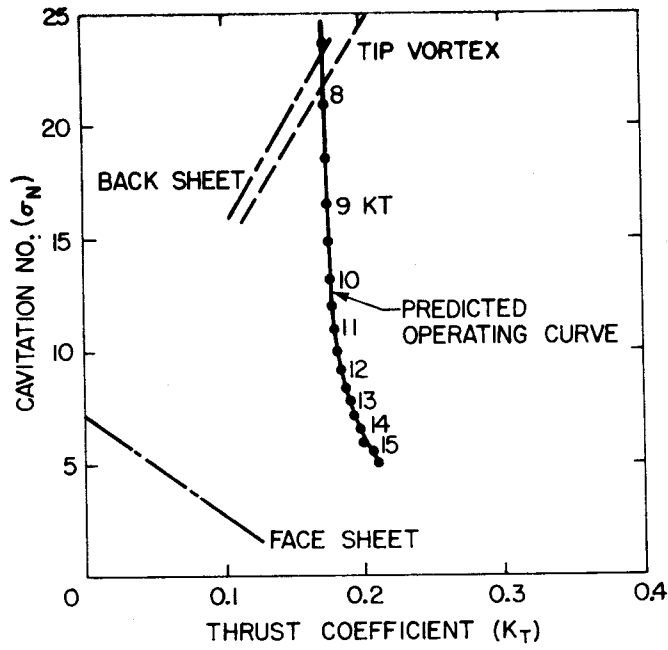

FIG. 9: CAVITATION INCEPTION, PROPELLER 5349, BEHIND CONDITION. DRAUGHT, 4650 MM.

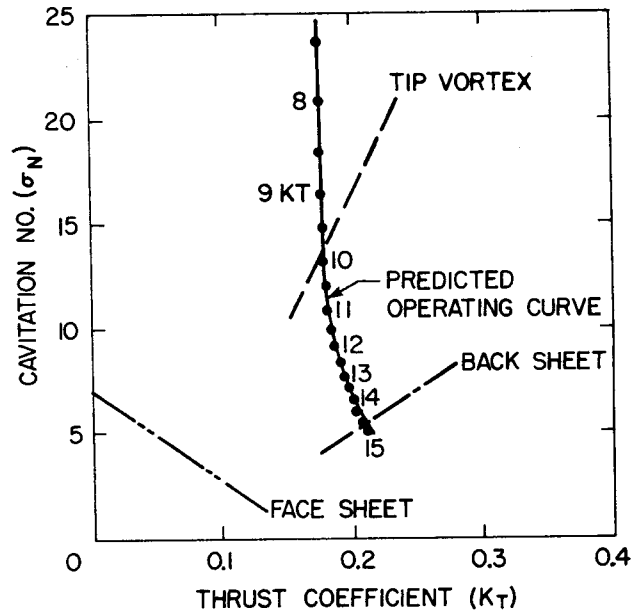

FIG. 10: CAVITATION INCEPTION, PROPELLER 5363, BEHIND CONDITION. DRAUGHT, 4650 MM.

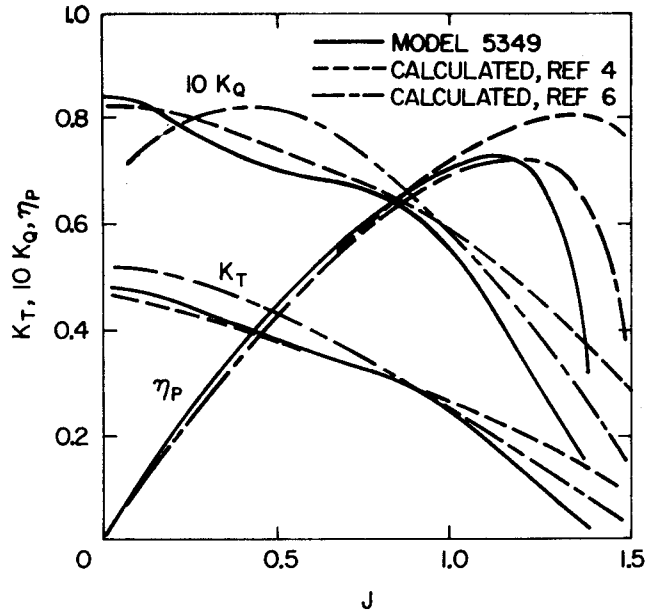

FIG. 11: CALCULATED AND MEASURED OPEN WATER DATA FOR PROPELLER 5349.

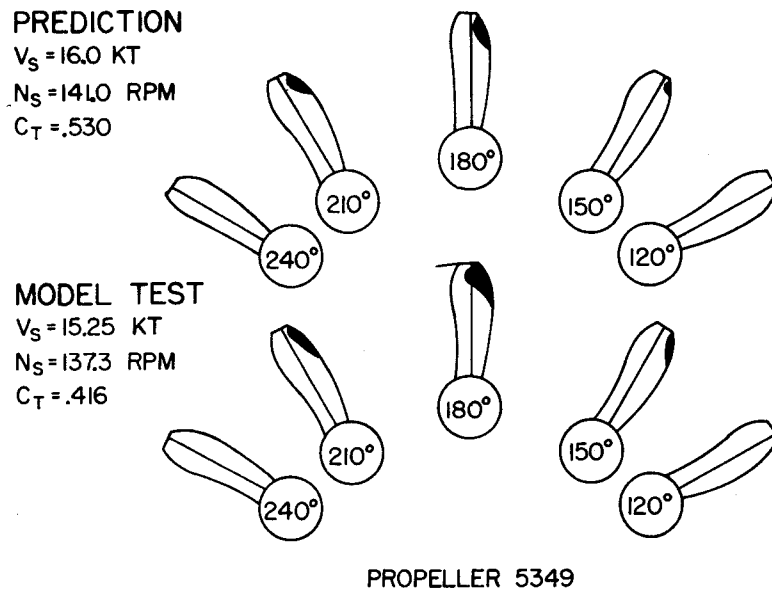
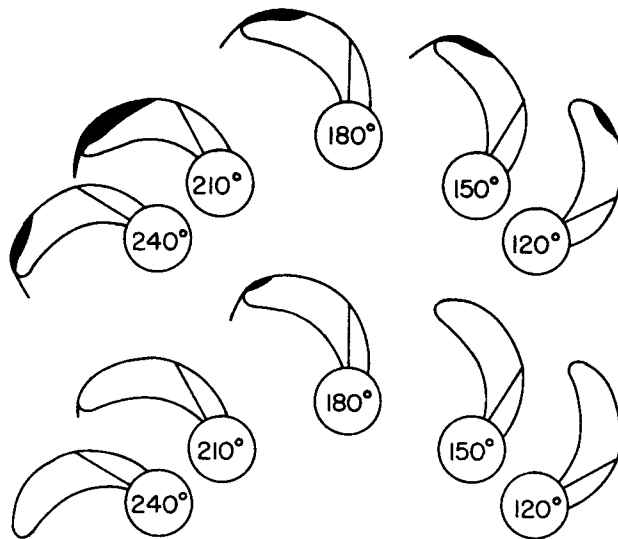

FIG. 12: CALCULATED AND MEASURED SUCTION-SIDE CAVITATION PATTERNS, PROPELLER 5349.



**PREDICTION**

$V_S = 16 \text{ KT}$   
 $N_S = 144 \text{ RPM}$   
 $C_T = 0.474$



**MODEL TEST**

$V_S = 15.42 \text{ KT}$   
 $N_S = 137.9 \text{ RPM}$   
 $C_T = 0.420$

(TIP ANGLE = BLADE ANGLE + 42°)  
PROPELLER 5363

FIG. 13: CALCULATED AND MEASURED SUCTION-SIDE CAVITATION PATTERNS, PROPELLER 5363.

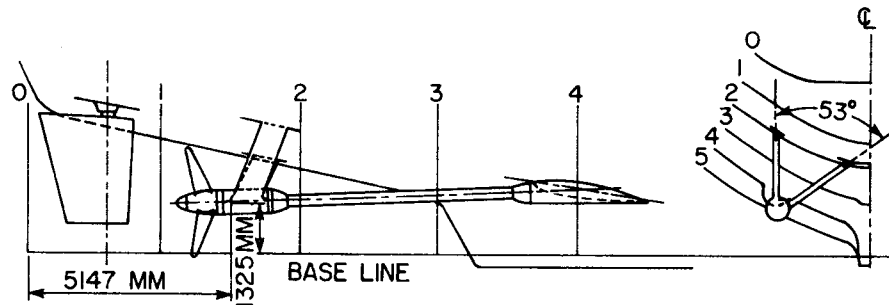

FIG. 14: PROPELLER, A-BRACKET, AND RUDDER ARRANGEMENT FOR THE A-BRACKET CONFIGURATION.

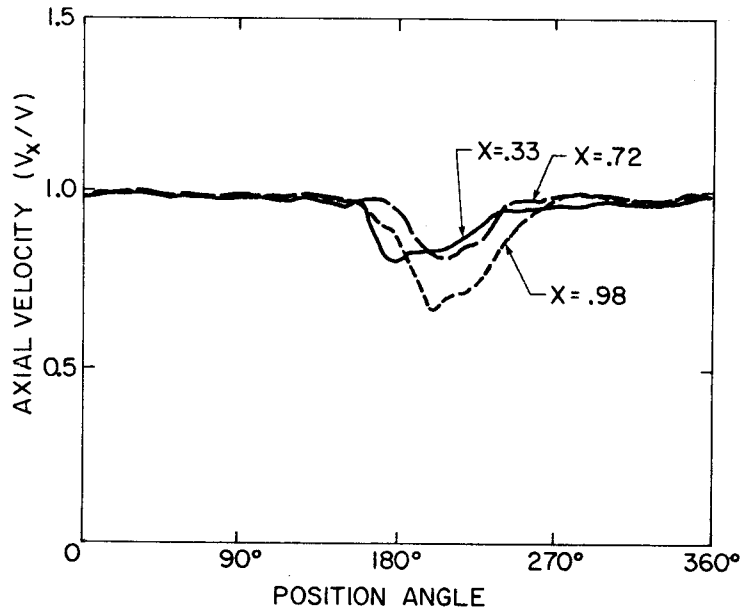

FIG. 15: AXIAL WAKE SURVEY IN PORT PROPELLER PLANE: A-BRACKET CONFIGURATION.

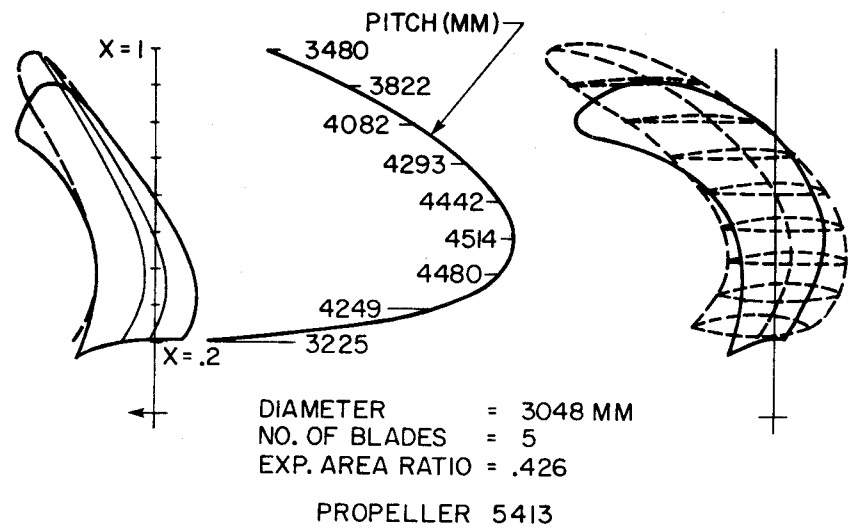
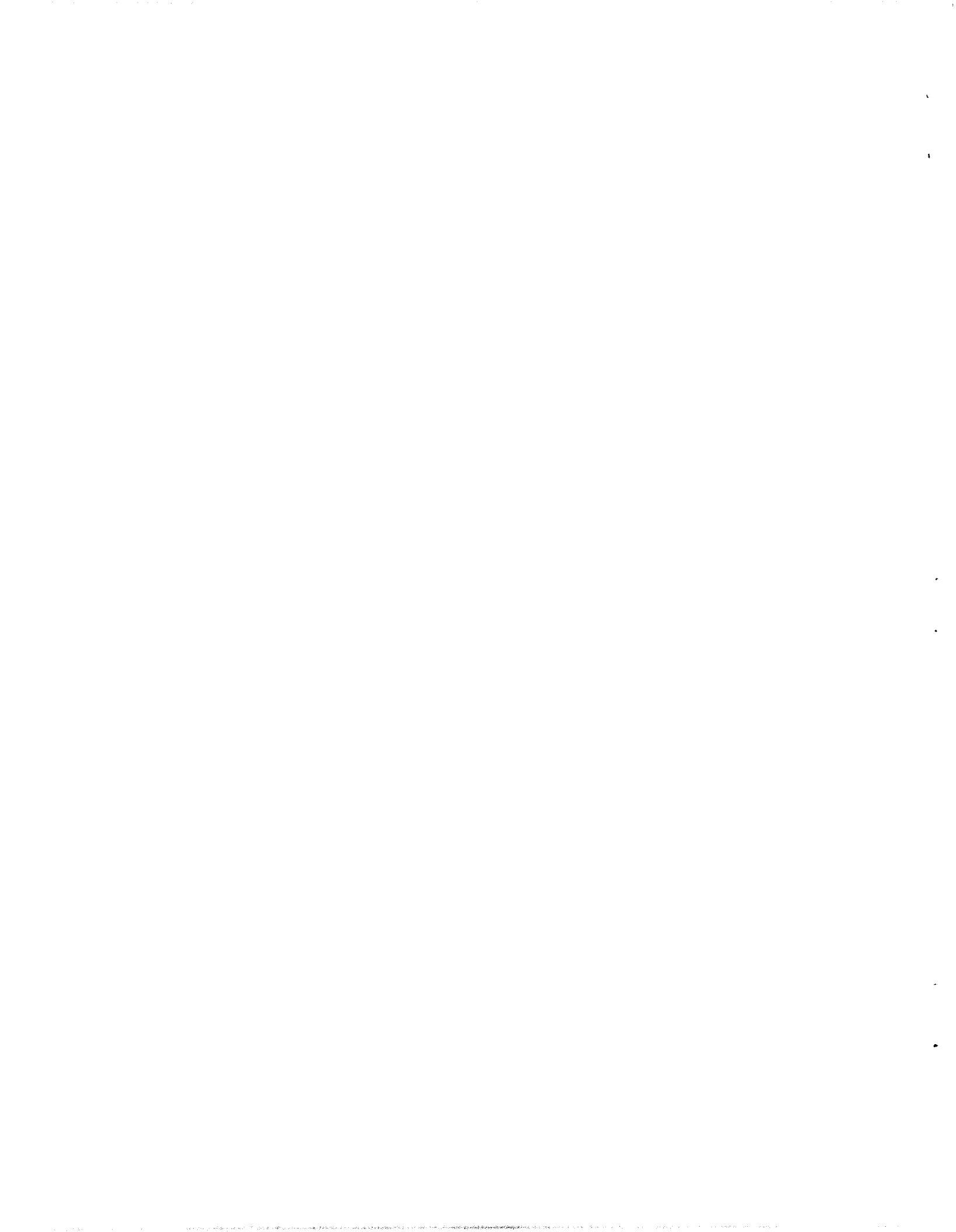

FIG. 16: GEOMETRY OF NEW PROPELLERS FOR A-BRACKET CONFIGURATION.

## REFERENCES

1. Collier, A.J., George A.J. "Acoustic Features of CFAV QUEST" presented at the 98th meeting of the Acoustical Society of America, 27 November 1979.
2. Straszack, J.S.C. "Propeller Design for NRE Vessel" National Research Council of Canada, Division of Mechanical Engineering Report No. MB 261, May 1964.
3. Kerwin, J.E., "Computer Techniques for Propeller Blade Section Design" Second Lips Propeller Symposium, Drunen, Holland, May 1973.
4. Taso, S.K.S., "Documentation of Programs for the Analysis of Performance and Spindle Torque of Controllable Pitch Propellers", MIT Dept. of Ocean Eng. Report 75-8.
5. Manen, J.D. van, "Fundamentals of Ship Resistance and Propulsion Part B", International Shipbuilding Progress Vol. 4, No. 30, February 1957.
6. Oossanen, P. van "Calculation of Performance and Cavitation Characteristics of Propellers, Including the Effects of Non-Uniform Flow". PhD thesis, Delft University of Technology, 1974. Also NSMB Publication 457.
7. Gent, W. van. "On the Use of Lifting Surface Theory for Moderately and Heavily Loaded Ship Propellers". PhD thesis, Delft University of Technology, May 1977.
8. Tothill, J.T., "AGOR 172, NRE Research Vessel Resistance and Propulsion Tests in Deep Condition with Bilge Keels", National Research Council of Canada, Division of Mechanical Engineering Report LTR-SH-21, February 1966.
9. Beausejour, J.P., and Kawerninski, L.I. "Measured Mile Trials on CFAV QUEST, Trial H-40" National Research Council of Canada, Division of Mechanical Engineering, Report No. LTR-SH-121, March 1972.
10. Cumming, R.A., Morgan, W.B., Boswell, R.J., "Highly Skewed Propellers". Trans. SNAME, Vol. 80, 1972.
11. Morgan, W.B., Silovic. V., and Denny, S.B., "Propeller Lifting Surface Corrections". Trans. SNAME, Vol. 76, 1968.

12. Romson, J.A., "Propeller Strength Calculations", Marine Eng. and Naval Arch., 1952.
13. Smith, D.R., "The Strength and Natural Frequencies of Vibration of the CFAV QUEST Propellers", DREA informal communication, January 1980.
14. Norwood, M.E., "Analysis of Shell Structures by Curved Finite Elements", Canplan Oceanology Limited Report, July 1974.
15. Holtrop, J. and Mennen, G.G.J., "A Statistical Power Prediction Method", International Shipbuilding Progress, Vol. 25, October 1978.
16. McCormick, Jr., B.W., "On Cavitation Produced by a Vortex Trailing from a Lifting Surface" Journal of Basic Engineering, Transactions of the ASME, September, 1962.
17. Lap, A.J.W., "Scale Effect in the Resistance of Bossing and Shaft Brackets", International Shipbuilding Progress, Vol. 4, No. 34, 1957.



DOCUMENT CONTROL DATA - R & D		
(Security classification of title, body of abstract and indexing annotation must be entered when the overall document is classified)		
1. ORIGINATING ACTIVITY Defence Research Establishment Atlantic	2a. DOCUMENT SECURITY CLASSIFICATION	
	2b. GROUP	
3. DOCUMENT TITLE PROPELLER DESIGN STUDIES FOR THE ACOUSTIC RESEARCH SHIP CFAV QUEST		
4. DESCRIPTIVE NOTES (Type of report and inclusive dates) DREA REPORT		
5. AUTHOR(S) (Last name, first name, middle initial) LEGGAT, L. JOHN; LIGTELIJN, J. THEODORE; KENNEDY, JAMES L.		
6. DOCUMENT DATE August 1981	7a. TOTAL NO. OF PAGES 28	7b. NO. OF REFS 17
8a. PROJECT OR GRANT NO.	9a. ORIGINATOR'S DOCUMENT NUMBER(S) DREA Report # 81/2	
8b. CONTRACT NO.	9b. OTHER DOCUMENT NO.(S) (Any other numbers that may be assigned this document)	
10. DISTRIBUTION STATEMENT UNLIMITED		(NON-CONTROLLED GOODS) DMC A REVIEW: GCEC December 2013
11. SUPPLEMENTARY NOTES	12. SPONSORING ACTIVITY	
13. ABSTRACT  CFAV QUEST is a specially designed quiet ship used for underwater acoustic research at the Defence Research Establishment Atlantic. QUEST was commissioned in 1969, however, advances in sonar technology since that time required additional silencing of the ship propellers. As a result, a joint propeller design and model test program was undertaken with the Netherlands Ship Model Basin.  The shortcomings of the present propellers are described and a comparison is given between model and full scale propulsion results. The design criteria and techniques used for a new set of propellers are reviewed, the suitability of the new propellers is assessed in relation to propulsion and cavitation criteria. Further, the effect on propeller performance and cavitation of modifying the shaft support from a bossing to an A-bracket is examined.		

KEY WORDS

Propeller design  
 Propulsion  
 Model tests

INSTRUCTIONS

1. **ORIGINATING ACTIVITY:** Enter the name and address of the organization issuing the document.
- 2a. **DOCUMENT SECURITY CLASSIFICATION:** Enter the overall security classification of the document including special warning terms whenever applicable.
- 2b. **GROUP:** Enter security reclassification group number. The three groups are defined in Appendix 'M' of the DRB Security Regulations.
3. **DOCUMENT TITLE:** Enter the complete document title in all capital letters. Titles in all cases should be unclassified. If a sufficiently descriptive title cannot be selected without classification, show title classification with the usual one-capital-letter abbreviation in parentheses immediately following the title.
4. **DESCRIPTIVE NOTES:** Enter the category of document, e.g. technical report, technical note or technical letter. If appropriate, enter the type of document, e.g. interim, progress, summary, annual or final. Give the inclusive dates when a specific reporting period is covered.
5. **AUTHOR(S):** Enter the name(s) of author(s) as shown on or in the document. Enter last name, first name, middle initial. If military, show rank. The name of the principal author is an absolute minimum requirement.
6. **DOCUMENT DATE:** Enter the date (month, year) of Establishment approval for publication of the document.
- 7a. **TOTAL NUMBER OF PAGES:** The total page count should follow normal pagination procedures, i.e., enter the number of pages containing information.
- 7b. **NUMBER OF REFERENCES:** Enter the total number of references cited in the document.
- 8a. **PROJECT OR GRANT NUMBER:** If appropriate, enter the applicable research and development project or grant number under which the document was written.
- 8b. **CONTRACT NUMBER:** If appropriate, enter the applicable number under which the document was written.
- 9a. **ORIGINATOR'S DOCUMENT NUMBER(S):** Enter the official document number by which the document will be identified and controlled by the originating activity. This number must be unique to this document.
- 9b. **OTHER DOCUMENT NUMBER(S):** If the document has been assigned any other document numbers (either by the originator or by the sponsor), also enter this number(s).
10. **DISTRIBUTION STATEMENT:** Enter any limitations on further dissemination of the document, other than those imposed by security classification, using standard statements such as:
  - (1) "Qualified requesters may obtain copies of this document from their defence documentation center."
  - (2) "Announcement and dissemination of this document is not authorized without prior approval from originating activity."
11. **SUPPLEMENTARY NOTES:** Use for additional explanatory notes.
12. **SPONSORING ACTIVITY:** Enter the name of the departmental project office or laboratory sponsoring the research and development. Include address.
13. **ABSTRACT:** Enter an abstract giving a brief and factual summary of the document, even though it may also appear elsewhere in the body of the document itself. It is highly desirable that the abstract of classified documents be unclassified. Each paragraph of the abstract shall end with an indication of the security classification of the information in the paragraph (unless the document itself is unclassified) represented as (TS), (S), (C), (R), or (U).  
  
The length of the abstract should be limited to 20 single-spaced standard typewritten lines; 7 1/4 inches long.
14. **KEY WORDS:** Key words are technically meaningful terms or short phrases that characterize a document and could be helpful in cataloging the document. Key words should be selected so that no security classification is required. Identifiers, such as equipment model designation, trade name, military project code name, geographic location, may be used as key words but will be followed by an indication of technical context.